

FOCUS ON LIFE SCIENCES CONSUMABLES



Biobank Consumables Solutions

ZHEJIANG RONGDA BIOTECHNOLOGY CO., LTD.

INTRODUCTION

Zhejiang Rongda Biotechnology Co., Ltd. was established in 2018. Our company's headquarter is located in Huangyan, Taizhou, an economically developed and scenic eastern coastal area in Zhejiang Province. We serve our customers with a science-based and quality-oriented spirit. Our company has a strong professional R&D team. At the same time, we have long-term cooperation with well-known domestic universities and scientific research institutions, and signed the contract of new products development and reagent experiments.

We adhere to the belief of "providing high-quality services for bioscience" and found the AMNGENT brand, focusing on cell culture, molecular biological consumables, biological sample library construction, safety management and the development and production of Class I and Class II diagnostic reagents. We continue to invest in high-end production equipment in the industry and introduce professional process technicians to form a new scientific management team. Our products have passed ISO9001, ISO13485, CE and other quality system certifications. AMNGENT continues to grow and develop, and our products are exported to companies in more than 80 countries and regions such as the United States and the European Union.

For the early-stage design and development of molds, our company also has a high-quality, professional and persistent team that makes full use of modern CAD/CAM design and the capabilities of a comprehensive CNC machining center to manufacture high-quality medical consumables and various molds.



DIRECTORY

Traditional Cryogenic vial.....	01
2D screw cap Cryogenic vial.....	06
2D auto-cap Cryogenic vial	09
SBS cryogenic vial.....	11
Cardboard Cryoboxes.....	14
Flip /Rivet Cardboard Cryoboxes	16
Plastic PP Cryoboxes.....	19
Plastic PC Cryoboxes	21
Cell Freezing Container for 12 x 1.5ml or 2Ml Cryo Tubes	23
Freezer Racks for Cryoboxes	24
Scanner	27
Semi-Automated Screw Cap Decapper/Recapper, Single Channel.....	27
Semi-Automated Screw Cap Decapper/Recapper, Multichannel.....	28
SBS Screw Cap Decapper/Recapper, full plate.....	28
Automated pipetting station.....	29
Recapper pipetting, Docking module.....	29
Cryogenic Vials CAPPING & DECAPPING	30
Low-temperature Label Printers & Labels.....	30
Sample Management Systems	31

Cryogenic vials - quality concept

To avoid exposing cell samples and their components to additional risks of contamination with disruptive substances during vital preservation' in Cryogenic tubes, all tubes have undergone a number of tests.

Having passed these defined test procedures, the Cryogenic tubes have been certified as follows:

- ✔ **Sterile**
- ✔ **Pyrogen-free/endotoxin-free**
- ✔ **Non-cytotoxic**
- ✔ **CE**

We guarantee that the following limits will not be exceeded:

- ▶ **Sterility validated according to the ISO 11137 series of standards**
- ▶ **Pyrogens/endotoxins < 0.01 EU/tube**
- ▶ **Non-cytotoxic in accordance with the ISO 10993 series of standards**



Traditional Cryogenic Vials

Product Feature

- Medical grade PP material: USP Biological Reactivity test report ,USP Plastic Class VI grade
- Non-Cytotoxicity
- RNase & Dnase free
- Pyrogen /Endotoxin free
- Heavy metal-free
- Sterile
- Standard 100,000 clean workshop production
- Temperature range: -196 to 121 °C (-320 to 250 °F)
- **CE**

*Above mentioned can provide third-party reports or associated product reports





- 0.5ml、1.0ml、1.5ml、2.0ml、5.0ml more volumes ok for options
- Ultra-transparent Cryo tubes are available with secure external thread and a volume of 0.5 to 5 ml to reduce the risk of contamination
For increased storage density (10 x 10 grid), a 2 ml Cryo tube with internal thread and silicone seal is available
- Cap color: white, red, yellow, blue, green, orange, purple for options
- Cap style :Flat , automatic cap, Higher cap, colour-coded inserts cap
Automatic cap:suitable for decapper/recapper
Flat cap&high cap & colour-coded insert cap: easy for label and writing record
High cap : easy take from cryoboxes
- Cap new technical , match with tube smooth and easy, Screw cap without damping



- Cap bottom design : easy for lock and one hand operation
- Tube two-tone printing: UV printing, Black scale mark+ white writing area, Clearly identify
White writing area suitable for watercolor pen, Mark pen, White-board writing, clearly and tidy
- Scale range : within ± 0.1
- Sealing : under -90Kpa ,15mins testing. 40°C constant temperature test .
Test reports are available
- Temperature range: -196 to 121°C (-320 to 250°F)



Ordering information

Traditional Cryogenic Vials — 0.5ml

Order No.	Color	Screw cap type	cap type	Sterile&Non-enzyme	Packing	Product images
66005X [X=0,1,2,3,4,5,6]		External thread	Flat cap	✓	50pcs/bag 20bags/case	

Traditional Cryogenic Vials — 1.0ml

Order No.	Color	Screw cap type	cap type	Sterile&Non-enzyme	Packing	Product images
66010X [X=0,1,2,3,4,5,6]		External thread	Flat cap	✓	50pcs/bag 20bags/case	

Traditional Cryogenic Vials — 1.5ml

Order No.	Color	Screw cap type	cap type	Sterile&Non-enzyme	Packing	Product images
66015X [X=0,1,2,3,4,5,6]		External thread	Flat cap	✓	50pcs/bag 20bags/case	

Traditional Cryogenic Vials — 2.0ml

Order No.	Color	Screw cap type	cap type	Sterile&Non-enzyme	Packing	Product images
66120X [X=0,1,2,3,4,5,6]		External thread	high cap	✓	50pcs/bag 20bags/case	
66220X [X=0,1,2,3,4,5,6]		External thread	Flat cap	✓	50pcs/bag 20bags/case	
66121X [X=0,1,2,3,4,5,6]		Internal thread	Internal thread cap	✓	50pcs/bag 20bags/case	
66221X [X=0,1,2,3,4,5,6]		Internal thread	Internal Thread with cap plug	✓	50pcs/bag 20bags/case	

Traditional Cryogenic Vials — 5.0ml

Order No.	Color	Screw cap type	cap type	Sterile&Non-enzyme	Packing	Product images
66050X [X=0,1,2,3,4,5,6]		External thread	Automatic cap	✓	50pcs/bag 20bags/case	

Traditional Cryogenic Vials — cap plug series

Order No.	Color	Fitter	Sterile&Non-enzyme	Packing	Product images
66000X [X=0,1,2,3,4,5,6]		fitted for 2ml internal rotation cryovial cap	✓	200pcs/bag 10bags/case	

◆ Dimension

Unit: mm

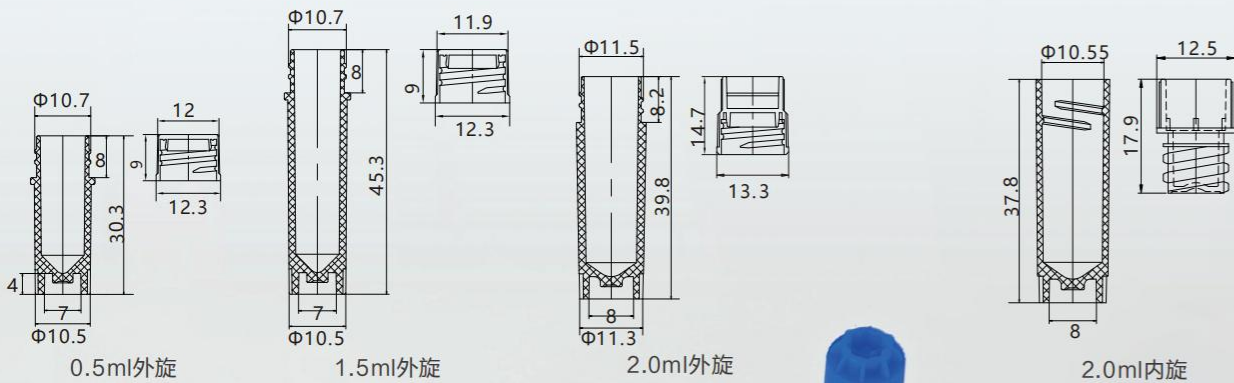

2D Cryogenic Vials

Product Feature

- Bottom QR code, tube side barcode and Number
- Laser etched 2D barcodes
- Scan time within 3sec 100pcs/rack
- 0.5ml 1.5ml 2.0ml suitable for 10*10 cryoboxes
5.0ml suitable for 9*9 cryoboxes For increased storage density



Ordering information

2D Cryogenic Vials — 0.5ml

Order No.	Color	Screw cap type	Tube side barcode	Bottom or Code	Sterile& Non-enzyme	box-packed	Packing	Product images
67005X [X=0,1,2,3,4,5,6]		External thread	✓	✗	✓	✗	50pcs/bag 20bags/case	
67605X [X=0,1,2,3,4,5,6]		External thread	✓	✓	✓	✗	50pcs/bag 10bags/inner box 2inner boxes/case	
68005X [X=0,1,2,3,4,5,6]		External thread	✓	✓	✓	✓	100pcs/rack 5rack/inner box 10rack/case	

2D Cryogenic Vials — 1.0ml

Order No.	Color	Screw cap type	Tube side barcode	Bottom or Code	Sterile& Non-enzyme	box-packed	Packing	Product images
67010X [X=0,1,2,3,4,5,6]		External thread	✓	✗	✓	✗	50pcs/bag 20bags/case	
67610X [X=0,1,2,3,4,5,6]		External thread	✓	✓	✓	✗	50pcs/bag 10bags/inner box 2inner boxes/case	
68010X [X=0,1,2,3,4,5,6]		External thread	✓	✓	✓	✓	100pcs/rack 5rack/inner box 10rack/case	

2D Cryogenic Vials — 1.5ml

Order No.	Color	Screw cap type	Tube side barcode	Bottom or Code	Sterile& Non-enzyme	box-packed	Packing	Product images
67015X [X=0,1,2,3,4,5,6]		External thread	✓	✗	✓	✗	50pcs/bag 20bags/case	
67615X [X=0,1,2,3,4,5,6]		External thread	✓	✓	✓	✗	50pcs/bag 10bags/inner box 2inner boxes/case	
68015X [X=0,1,2,3,4,5,6]		External thread	✓	✓	✓	✓	100pcs/rack 5rack/inner box 10rack/case	

2D Cryogenic Vials — 2.0ml

Order No.	Color	Screw cap type	Tube side barcode	Bottom or Code	Sterile & Non-enzyme	box-packed	Packing	Product images
67120X [X=0,1,2,3,4,5,6]		External thread	✓	✗	✓	✗	50pcs/bag 20bags/case	
67220X [X=0,1,2,3,4,5,6]		Flat cap	✓	✗	✓	✗	50pcs/bag 20bags/case	
67121X [X=0,1,2,3,4,5,6]		Internal thread	✓	✗	✓	✗	50pcs/bag 20bags/case	
67221X [X=0,1,2,3,4,5,6]		Internal Thread with cap plug	✓	✗	✓	✗	50pcs/bag 20bags/case	
67620X [X=0,1,2,3,4,5,6]		External thread	✓	✓	✓	✗	50pcs/bag 10bags/inner box 2inner boxes/case	
67621X [X=0,1,2,3,4,5,6]		Internal thread	✓	✓	✓	✗	50pcs/bag 10bags/inner box 2inner boxes/case	
67622X [X=0,1,2,3,4,5,6]		Internal Thread with cap plug	✓	✓	✓	✗	50pcs/bag 10bags/inner box 2inner boxes/case	
68121X [X=0,1,2,3,4,5,6]		Internal thread	✓	✓	✓	✓	100pcs/rack 5rack/inner box 10rack/case	
68221X [X=0,1,2,3,4,5,6]		Internal Thread with cap plug	✓	✓	✓	✓	100pcs/rack 5rack/inner box 10rack/case	
68120X [X=0,1,2,3,4,5,6]		External thread	✓	✓	✓	✓	100pcs/rack 5rack/inner box 10rack/case	

2D Cryogenic Vials — 5.0ml

Order No.	Color	Screw cap type	Tube side barcode	Bottom or Code	Sterile & Non-enzyme	box-packed	Packing	Product images
67050X [X=0,1,2,3,4,5,6]		External thread	✓	✗	✓	✗	50pcs/bag 5bags/inner box 4inner boxes/case	
67850X [X=0,1,2,3,4,5,6]		Automatic cap	✓	✓	✓	✗	50pcs/bag 5bags/inner box 4inner boxes/case	
68850X [X=0,1,2,3,4,5,6]		Automatic cap	✓	✓	✓	✓	81pcs/rack 5rack/inner box 10rack/case	

2D Automatic Cap Cryogenic Vials

Product Feature

- Upgrade to automatic cap from normal screw cap
- Suitable: Auto Pipetting workstation, Automatic pipette tips, ultra-low temperature freezer
- Suitable : Hold the lid decapper, full plate decapper, achieve automatic high throughput switch cover



Ordering information

2D Automatic Cap Cryogenic Vials — 0.5ml

Order No.	Color	Screw cap type	Tube side barcode	Bottom or Code	Sterile & Non-enzyme	box-packed	Packing	Product images
67805X [X=0,1,2,3,4,5,6]		Automatic cap	✓	✓	✓	X	50pcs/bag 10bags/inner box 2 inner boxes/case	
68805X [X=0,1,2,3,4,5,6]		Automatic cap	✓	✓	✓	✓	100pcs/rack 5rack/inner box 10rack/case	

2D Automatic Cap Cryogenic Vials — 1.5ml

Order No.	Color	Screw cap type	Tube side barcode	Bottom or Code	Sterile & Non-enzyme	box-packed	Packing	Product images
67815X [X=0,1,2,3,4,5,6]		Automatic cap	✓	✓	✓	X	50pcs/bag 10bags/inner box 2 inner boxes/case	
68815X [X=0,1,2,3,4,5,6]		Automatic cap	✓	✓	✓	✓	100pcs/rack 5rack/inner box 10rack/case	

2D Automatic Cap Cryogenic Vials — 2.0ml

Order No.	Color	Screw cap type	Tube side barcode	Bottom or Code	Sterile & Non-enzyme	box-packed	Packing	Product images
67820X [X=0,1,2,3,4,5,6]		Automatic cap	✓	✓	✓	X	50pcs/bag 10bags/inner box 2 inner boxes/case	
68820X [X=0,1,2,3,4,5,6]		Automatic cap	✓	✓	✓	✓	100pcs/rack 5rack/inner box 10rack/case	

2D Automatic Cap Cryogenic Vials — 5.0ml

Order No.	Color	Screw cap type	Tube side barcode	Bottom or Code	Sterile & Non-enzyme	box-packed	Packing	Product images
67850X [X=0,1,2,3,4,5,6]		Automatic cap	✓	✓	✓	X	50pcs/bag 5bags/inner box 4 inner boxes/case	
68850X [X=0,1,2,3,4,5,6]		Automatic cap	✓	✓	✓	✓	81pcs/rack 5rack/inner box 10rack/case	

SBS Cryogenic Vials

Product Feature

- Medical grade PP material: USP Biological Reactivity test report ,USP Plastic Class VI grade
- Non-Cytotoxicity
- RNase & Dnase free
- Pyrogen /Endotoxin free
- Heavy metal-free
- Sterile
- Standard 100,000 clean workshop production
- Temperature range: -196 to 121 °C (-320 to 250 °F)
- **CE**

*Above mentioned can provide third-party reports or associated product reports

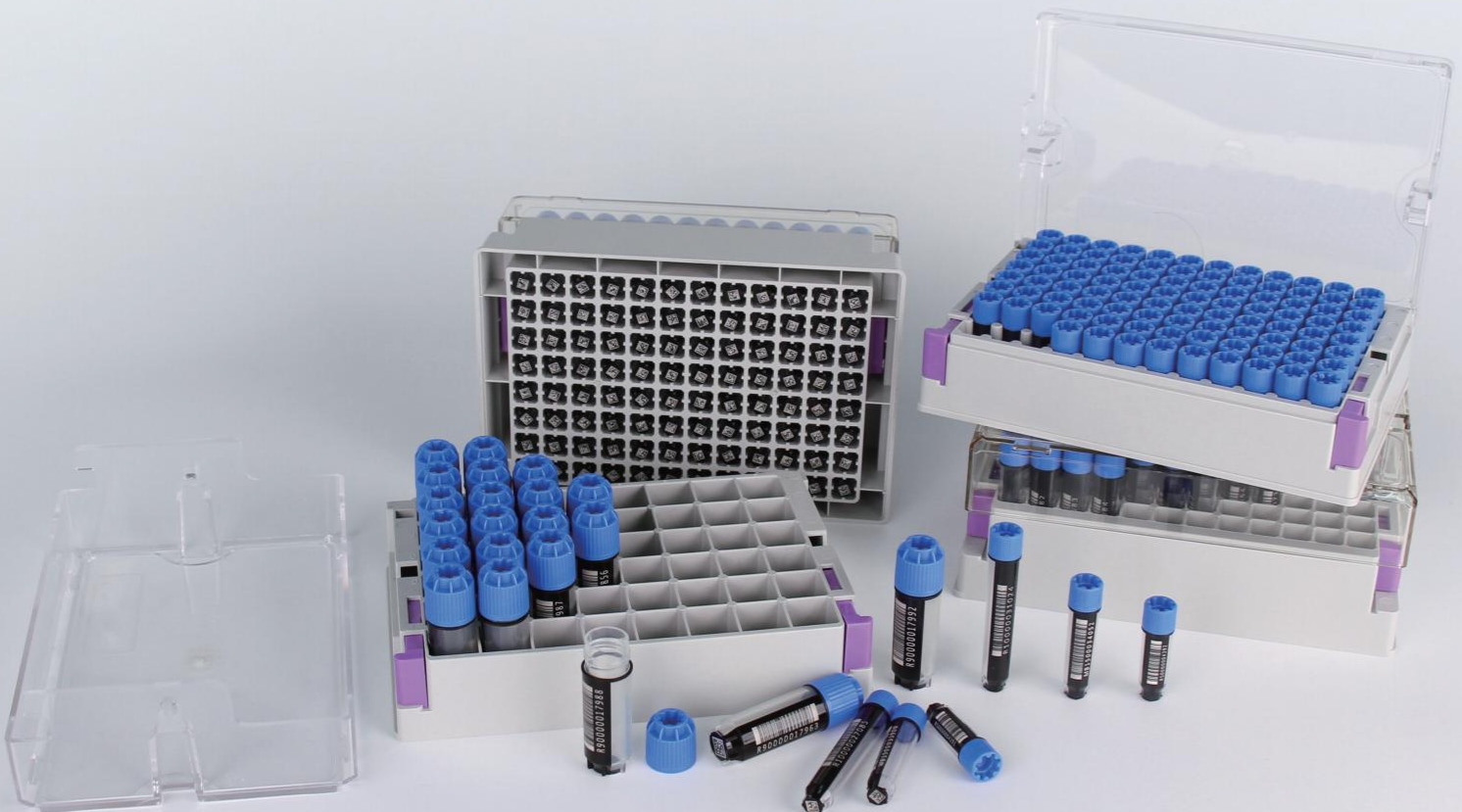

AMNGENT new SBS offers you the possibility to save between 35% and 50% of your freezer space

- 0.5ml, 1.0ml, 1.5ml, 2.0ml more size for options
- Scan 3second 96pcs/rack
- Automatic cap suitable for Single channel, multi channel decapper/recapper
- 2D Data-Matrix coded on tube. barcodes on the side of SBS format racks, Ensure the sample is safe and traceable, Laser etched 2D barcodes, resistant to DMSO and other organic solvents
- Rack format: 0.5ml,0.75ml,1.0ml 96well format
2.0ml 48well format
- Latch lock design,safety shipping
- Lid ok 90°right angle place on the rack.

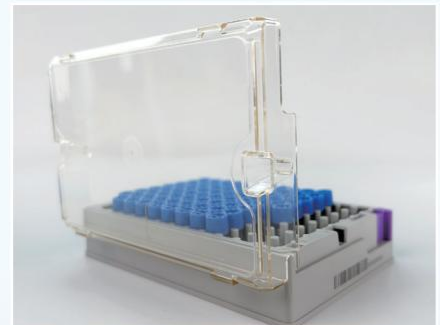
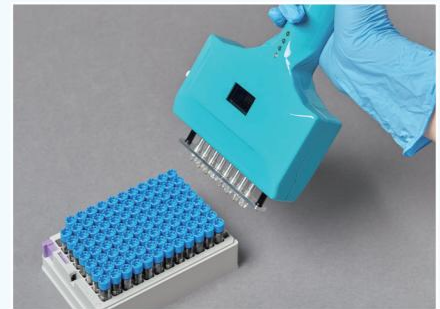

Ordering information

SBS Cryogenic Vials — 0.5ml

Order No.	Pack Style	Screw cap type	3-In-1	Sterile& Non-enzyme	Packing	Product images
674500	SBS tube + bag pack	External thread	✓	✓	96pcs/bag 20bags/case	
684500	SBS tube+SBS rack	External thread	✓	✓	96pcs/rack 10rack/inner box 20rack/case	

SBS Cryogenic Vials — 0.75ml

Order No.	Pack Style	Screw cap type	3-In-1	Sterile& Non-enzyme	Packing	Product images
674750	SBS tube + bag pack	External thread	✓	✓	96pcs/bag 20bags/case	
684750	SBS tube+SBS rack	External thread	✓	✓	96pcs/rack 10rack/inner box 20rack/case	

SBS Cryogenic Vials — 1.0ml

Order No.	Pack Style	Screw cap type	3-In-1	Sterile& Non-enzyme	Packing	Product images
674101	SBS tube + bag pack	External thread	✓	✓	96pcs/bag 20bags/case	
684101	SBS tube+SBS rack	External thread	✓	✓	96pcs/rack 10rack/inner box 20rack/case	

SBS Cryogenic Vials — 2.0ml

Order No.	Pack Style	Screw cap type	3-In-1	Sterile& Non-enzyme	Packing	Product images
674201	SBS tube + bag pack	External thread	✓	✓	96pcs/bag 20bags/case	
684201	SBS tube+SBS rack	External thread	✓	✓	96pcs/rack 10rack/inner box 20rack/case	

Cardboard Cryo boxes

Product Feature

- Two sides super white & strong cardboard material
- Waterproof coating, white glossy and color matte film for options
- Available in Various material insert or divider
- Available in different heights
- 2inch Cryoboxes suitable for 1.5ml & 2.0ml cryogenic tube.
- Temperature range: -196 to 121 °C (-320 to 250 °F), Used for liquid nitrogen preservation after punching

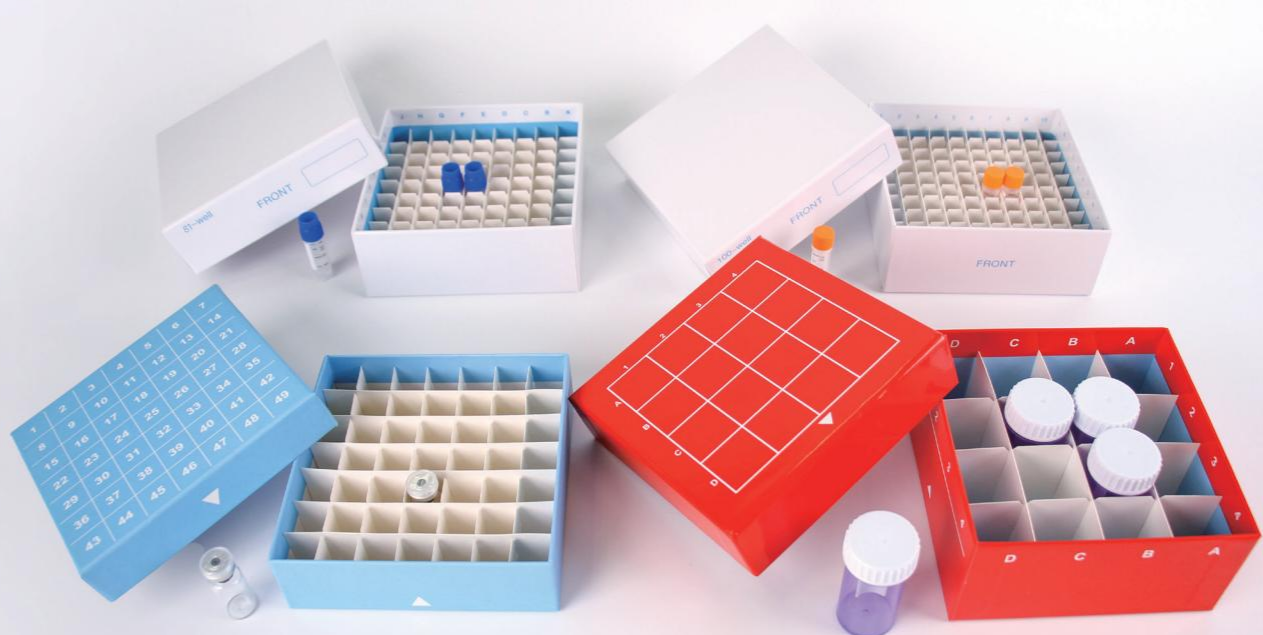
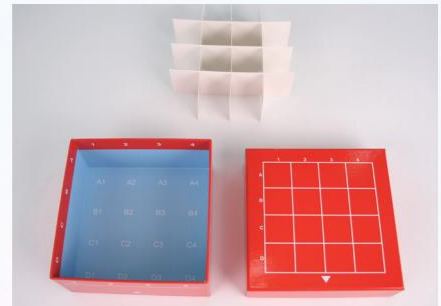

Ordering information



Cardboard Cryo boxes — 16well

Order No.	Height	External size	Color	Film	Packing	Product images
810316	2inch	133*133*62mm		Red surface matte film	4pcs/bag 10bag/case	



Cardboard Cryo boxes — 49well

Order No.	Height	External size	Color	Film	Packing	Product images
810249	2inch	133*133*42mm		Blue surface matte film	6pcs/bag 10bag/case	

Cardboard Cryo boxes — 81well

Order No.	Height	External size	Color	Film	Packing	Product images
810281	2inch	133*133*52mm		White surface matte film	5pcs/bag 10bag/case	

Cardboard Cryo boxes — 100well

Order No.	Height	External size	Color	Film	Packing	Product images
810200	2inch	133*133*52mm		White surface matte film	5pcs/bag 10bag/case	

Dimension

Unit: mm

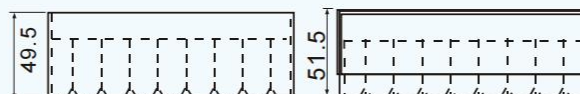
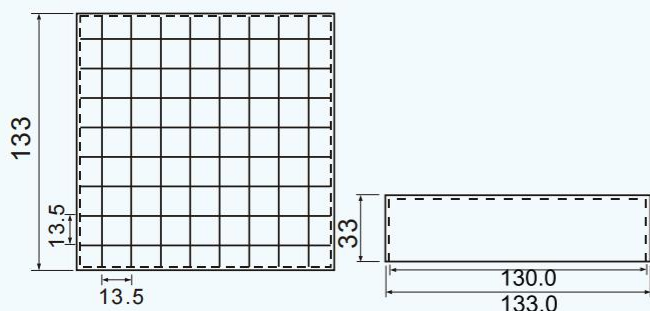

810281

Hinged lid Cardboard Cryoboxes / Rivet Cryoboxes

Product Feature

- Waterproof coating, both sides, plastic divider
- Plastic PP divider
- Lid, bottom,side all have numbers for record,Convenience sample location

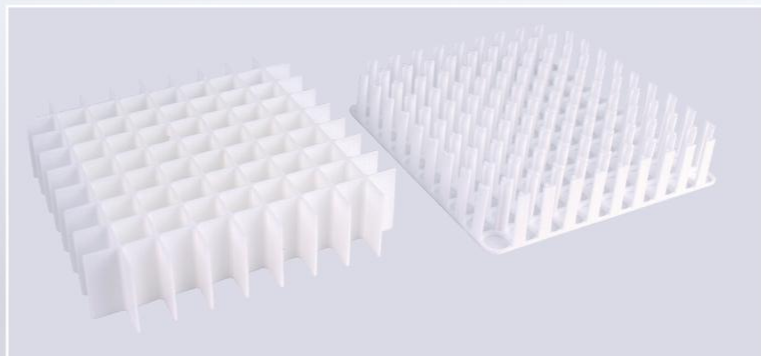

- Hinged lid design easy for storage, in case lid lost
- Available in different heights 1inch 100well ,2inch 100well & 81well,3.75inch 81well ,Customization
- Suitable for 0.5ml, 1.0ml, 1.5ml, 2.0ml, 5.0ml tubes or 1.5ml, 2.0ml micro centrifuge tubes, 15ml , 50ml centrifuge tubes
- Liquid nitrogen special glue, can achieve long-term use in liquid nitrogen environment
- 133*133mm standard size, suitable for different size freezer rack
- Temperature range: -196 to 121 °C (-320 to 250 °F), Used for liquid nitrogen preservation after punching



Ordering information

Flip /Rivet Cardboard — 81well

Order No.	Height	External size	Rivet	Divider	Packing	Product images
820281	2inch	133*133*52mm	X	PP	5pcs/bag 10bag/case	
820381	3.75inch	133*133*95mm	X	PP	3pcs/bag 10bag/case	
830281	2inch	133*133*52mm	✓	PP	5pcs/bag 10bag/case	

Flip /Rivet Cardboard — 100well

Order No.	Height	External size	Rivet	Divider	Packing	Product images
820100	1inch	133*133*36mm	X	PP	8pcs/bag 10bag/case	
820200	2inch	133*133*52mm	X	PP	5pcs/bag 10bag/case	
830100	1inch	133*133*36mm	✓	PP	5pcs/bag 10bag/case	
830200	2inch	133*133*52mm	✓	PP	5pcs/bag 10bag/case	

Dimension

Unit: mm

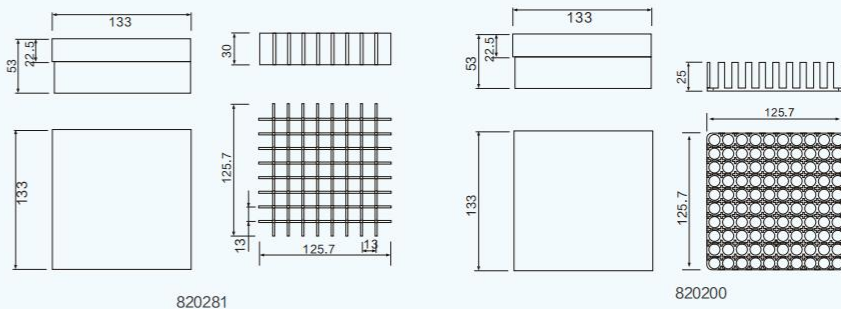

820281

820200

PP Cryo boxes

Product Feature

- Medical Grade PP Material, USP Biological Reactivity test report , chemically resistant to alcohols and mild organic solvents
- Five assorted colors available
- Numbered grids for sample identification
- Can be repeatedly frozen
- 9x9 (81-well) ,10x10 (100-well)hinged and top and bottom for options
- 81-well & 100-well hinged lid Compatible with 1.5ml & 2.0ml micro-tubes and cryogenic vials. 100-well top and bottom shape suitable for 1.5ml microtubes and cryogenic vials
- Drain holes and air vents minimize condensation
- 133*133mm standard size, suitable for different size freezer rack
- Working temperature: stable from -86°C to 121°C(-187 to 250 °F)

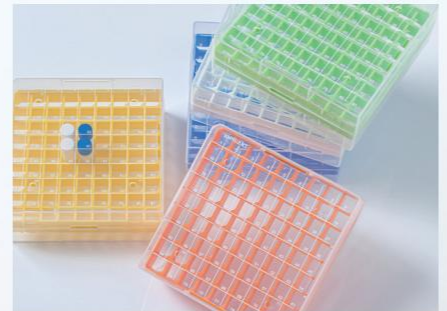

Ordering information

PP Cryoboxes — 81well

Order No.	Height	External size	Color	Packing	Product images
821281	2inch	132*132*52mm	Assorted Color	5pcs/bag 4bag/case	
821281-W/R/B/Y/G	2inch	132*132*52mm	Transparent White/red/ blue/yellow/green	5pcs/bag 4bag/case	

PP Cryoboxes — 100well

Order No.	Height	External size	Color	Packing	Product images
821200	2inch	132*132*53mm	Assorted Color	5pcs/bag 4bag/case	
821200-W/R/B/Y/G	2inch	132*132*53mm	Transparent White/red/ blue/yellow/green	5pcs/bag 4bag/case	
821201	2inch	140*154*53mm	Assorted Color	5pcs/bag 4bag/case	
821201-W/R/B/Y/G	2inch	140*154*53mm	Transparent White/red/ blue/yellow/green	5pcs/bag 4bag/case	

Dimension

Unit: mm

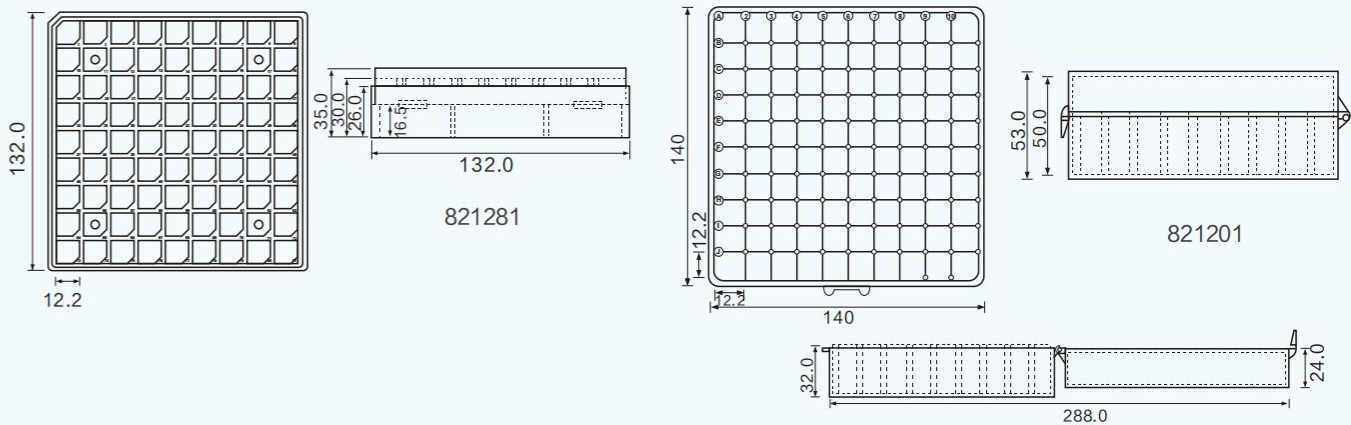

PC Cryoboxes

Product Feature

- Made with PC material. Durable, all-plastic storage box for short- or long-term storage
- Boxes are stackable. Designed for 5x5 (25well), 9x9 (81well), or 10x10 (100well) places to store both internal and external threaded vials (0.5ml - 5 ml).
- Printed grid on plastic lids for easy inventory management
- Fast and exact place corner cut design
- Available in a variety of color options. red, blue, green, white, and yellow
- Working Temperature range: -196 to 121 °C (-320 to 250 °F), Used for Ultra-low temperature freezer and liquid nitrogen environment

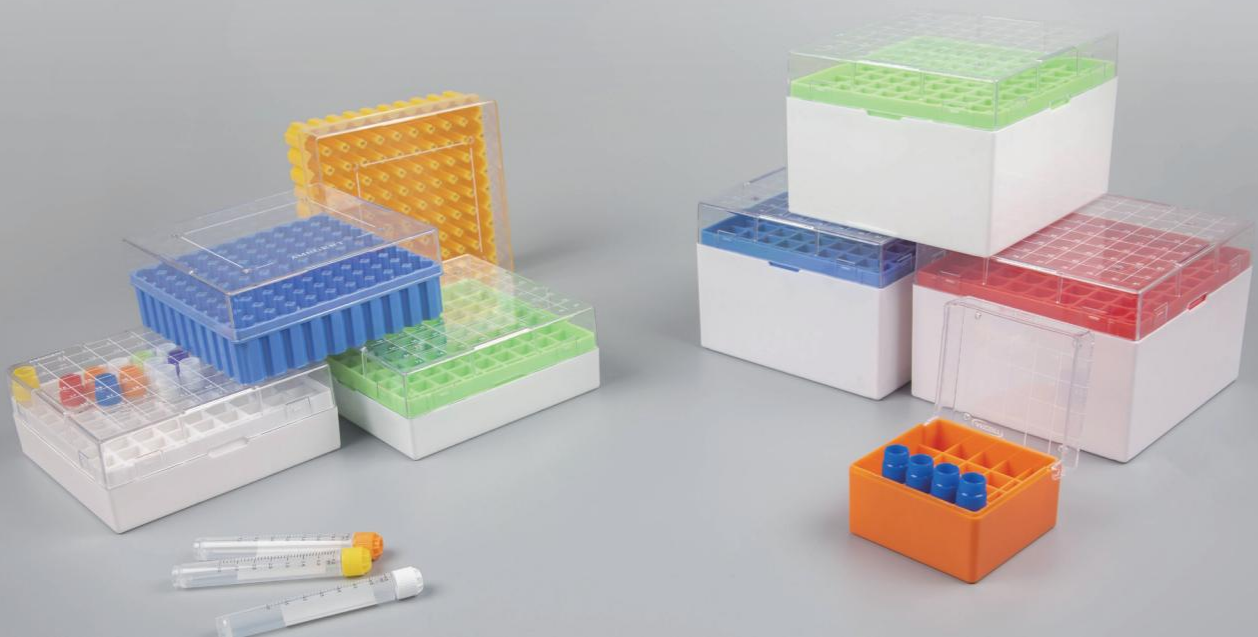

Ordering information

PC Cryoboxes — 25well

Order No.	Height	External size	Color	Packing	Product images
822225	2inch	73*73*52mm		5pcs/bag 6bag/case	

PC Cryoboxes — 81well

Order No.	Height	External size	Color	Packing	Product images
822281	2inch	132*132*53mm	Assorted Color	5pcs/bag 4bag/case	
822281-W/R/B/Y/G	2inch	132*132*53mm		5pcs/bag 4bag/case	
822381	3.75inch	133*133*96mm	Assorted Color	5pcs/bag 4bag/case	
822381-W/R/B/Y/G	3.75inch	133*133*96mm		5pcs/bag 4bag/case	
861500	3.75inch	133*133*96mm			

PC Cryoboxes — 100well

Order No.	Height	External size	Color	Packing	Product images
822200	2inch	132*132*53mm	Assorted Color	5pcs/bag 4bag/case	
822200-W/R/B/Y/G	2inch	132*132*53mm		5pcs/bag 4bag/case	
861100	1inch	132*132*36mm		5pcs/bag 4bag/case	
861150	2inch	132*132*53mm		5pcs/bag 4bag/case	
861200	2inch	136*136*53mm		5pcs/bag 4bag/case	

Cell Freezing Container for 12 x 1ml or 2ml Cryo Tubes

Product Feature

- Alcohol-free Cell Freezing Containers for 12 x 1ml or 2ml Cryo Tubes ensure controlled-rate $-1^{\circ}\text{C}/\text{minute}$ cell freezing in a -80°C freezer.
- No alcohol or fluids required
- Consistent heat removal through freezing period.
- Unbreakable, easy and safe to open when frozen
- For use with stem cells, primary cells and cell lines
- Suitable for 1.0ml .15ml 2.0ml cryogenic tubes



Ordering information

Order No.	Capacity	Match	Packaging
900112	12pcs	1.0ml, 1.5ml, 2.0ml cryogenic vials	1pcs/carton



Freezer rack, Cryobank

Product Feature

- Options include durable stainless-steel and aluminum racks that fit most common upright and chest freezers
- Conveniently store standard 5-1/4 x 5-1/4 cryogenic vial storage boxes with these freezer racks
- Vertical & Horizontal & Chest Freezer Racks
- Alternative color signs, can be marked in frost environment
- Color :Silver
- Customization



Ordering information

Horizontal Freezer Racks-thickness 0.4-0.5mm

Item No.	Material	Design	Dimensions(D*W*H)	Holds	Box size	Product images
701212	Stainless-Steel	Horizontal	422*137*229mm	3*4	133*133*52mm	
701215	Stainless-Steel	Horizontal	422*137*284mm	3*5	133*133*52mm	
701216	Stainless-Steel	Horizontal	560*137*229mm	4*4	133*133*52mm	
701220	Stainless-Steel	Horizontal	560*137*284mm	4*5	133*133*52mm	
701224	Stainless-Steel	Horizontal	560*137*339mm	4*6	133*133*52mm	
701225	Stainless-Steel	Horizontal	696*137*284mm	5*5	133*133*52mm	

Slide-Out Freezer Rack-thickness0.5-1.0mm

Item No.	Material	Design	Dimensions(D*W*H)	Holds	Box size	Product images
702212	Stainless-Steel	Horizontal	420*141*229mm	3*4	133*133*52mm	
702215	Stainless-Steel	Horizontal	420*141*285mm	3*5	133*133*52mm	
702216	Stainless-Steel	Horizontal	564*141*229mm	4*4	133*133*52mm	
702220	Stainless-Steel	Horizontal	560*141*285mm	4*5	133*133*52mm	
702224	Stainless-Steel	Horizontal	560*141*341mm	4*6	133*133*52mm	
702225	Stainless-Steel	Horizontal	700*141*285mm	5*5	133*133*52mm	

upright freezer sliding rack-thickness0.5-1.0mm

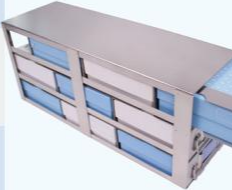
Item No.	Material	Design	Dimensions(D*W*H)	Holds	Box size	Product images
703212	Stainless-Steel	Horizontal	420*141*229mm	3*4	133*133*52mm	
703216	Stainless-Steel	Horizontal	564*141*229mm	4*4	133*133*52mm	
703220	Stainless-Steel	Horizontal	564*141*285mm	4*5	133*133*52mm	
703224	Stainless-Steel	Horizontal	564*141*341mm	4*6	133*133*52mm	
703225	Stainless-Steel	Horizontal	700*141*285mm	5*5	133*133*52mm	

Horizontal freezer rack-Thickness 0.4mm-0.8mm combine

Item No.	Material	Design	Dimensions(D*W*H)	Holds	Box size	Product images
704210	Stainless-Steel	Vertical	143*137*560mm	1*10	133*133*52mm	
704211	Stainless-Steel	Vertical	143*137*616mm	1*11	133*133*52mm	
704212	Stainless-Steel	Vertical	143*137*672mm	1*12	133*133*52mm	
704213	Stainless-Steel	Vertical	143*137*728mm	1*13	133*133*52mm	
704214	Stainless-Steel	Vertical	143*137*784mm	1*14	133*133*52mm	
704215	Stainless-Steel	Vertical	143*137*840mm	1*15	133*133*52mm	

Self-fixed Horizontal freezer rack-Thickness 0.4mm-0.8mm

Item No.	Material	Design	Dimensions(D*W*H)	Holds	Product images
735207	Stainless-Steel	Vertical	137*137*394mm	1*7	
735208	Stainless-Steel	Vertical	137*137*450mm	1*8	
735209	Stainless-Steel	Vertical	137*137*506mm	1*9	
735210	Stainless-Steel	Vertical	137*137*562mm	1*10	
735211	Stainless-Steel	Vertical	137*137*618mm	1*11	
735212	Stainless-Steel	Vertical	137*137*674mm	1*12	
735213	Stainless-Steel	Vertical	137*137*751mm	1*13	
735214	Stainless-Steel	Vertical	137*137*808mm	1*14	
735215	Stainless-Steel	Vertical	137*137*865mm	1*15	
736207	Stainless-Steel	Vertical of SBS box	135*96*388mm	1*7	
736213	Stainless-Steel	Vertical of SBS box	135*96*712mm	1*13	
736214	Stainless-Steel	Vertical of SBS box	135*96*766mm	1*14	
736215	Stainless-Steel	Vertical of SBS box	135*96*820mm	1*15	

Reader & Scanner

Reader

- USB link, plug and play
- Both ok scan for Barcodes and QR codes
- Infrared technology, high-speed identification



Third Generation Scanner

- Compatible with 133*133mm cryogenic box & SBS scanner
- Reader time: ≤ 1.5 seconds.
- Plug and play, no software installation required.
- Anti fog treatment, To improve the recognition rate of cryogenic tubes after frosting
- Using HTTP service interface, it can be connected to any software database.







Description	Order No.	Design	Packaging Specifications
Reader	691101	single scan	1pcs/carton
Third Generation Scanner	692103	rack scan	1set/carton

Semi-Automated Screw Cap Decapper/Recapper, Single Channel

Product Feature

- 1 second fast Automatic column type open and close the cover
- Long battery standby time, standby time ≥ 30 days.
- Quiet type, the noise of recapper is ≤ 5 decibels.
- Customization for recapper gear, fit multiple brands of SBS cryovials







Order No.	Suitable for	Cap stype	Packaging Specifications
696001	0.5ml、0.75ml、1.0ml SBS cryogenic vials		1pcs/carton
696002	0.5ml、1.5ml 2D Automatic Cryogenic vials		1pcs/carton
696003	2.0ml 2D Automatic Cryogenic vials		1pcs/carton
696004	2.0ml SBS cryogenic vials		1pcs/carton

Semi-Automated Screw Cap Decapper/Recapper, Multichannel

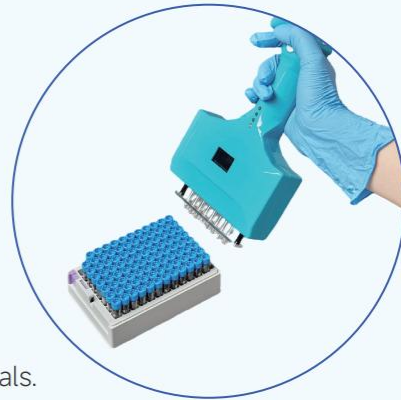
Product Feature

- 3 second fast Automatic column type open and close the cap
- Long battery standby time, standby time ≥ 30 days.
- Quiet type, the noise of recapper is ≤ 5 decibels.
- Customization for recapper gear, fit multiple brands of SBS cryovials.







Order No.	Channel	Suitable for	Cap style	Packaging Specifications
695005	5 channels	0.5ml, 1.5ml 2D Automatic Cryogenic vials		1pcs/carton
695006	6 channels	2.0ml SBS cryogenic vials		1pcs/carton
695008	8 channels	0.5ml, 0.75ml, 1.0ml SBS cryogenic vials		1pcs/carton

SBS Screw Cap Decapper/Recapper, full plate

Product Feature

- Integrate automated workflows.
- Independent motor system, real-time monitoring of torque and torsion.
- Compatible with SBS 48-well, 96-well plate rack and 133*133mm plate rack.
- The full plate opening time is ≤ 10 seconds.



Order No.	Suitable for	Cap style	Packaging Specifications
695096	0.5ml, 0.75ml, 1ml, 2ml whole plate SBS cryotube	 	1set/carton
695100	0.5ml, 1.5ml, 2ml, 5ml 81 grid/100 grid whole box frozen storage tube	 	1set/carton

Automated pipetting station

Product Feature

- Sample safety:** the sample does not need to leave the carrier frame after entering the system and does not disturb the layered interface; Pneumatic type
Pipetting channel, low discharge function, minimize the possibility of aerosol contamination
- Data security:** automatic barcode scanning, automatic entry of sample information; The whole process of sample processing data was recorded
Record and store images of each sample to ensure traceability
- Process security:** 6 megapixel industrial camera module to ensure clear and accurate image recognition;
1000ul independent pipetting channels ensured accurate dispensing of each sample
- More suitable for Chinese scientific research work:** multi-point suction; Graphical wizard operation, you can adjust the height



Order No.	Pipetting range	Accuracy of pipetting	Pipetting channel	Bar code scanning	Packaging Specifications
699000	5-1000ul, 1000ul, 200UL, 50ul can be used	5ul<6% 100ul<5%	Independent pipetting channels	The recognition speed was 2 seconds	1set/carton

Recapper pipetting, Docking module

Product Feature

- Whole plate recapper and pipette station
- Through the communication port or sensor, the whole box cryogenic tube can be no packing operation by opening -- pipetting -- closing
- Pipetting time: ≤5Seconds
- Customization

Order No.	Packaging Specifications
698000	1set/carton

Noted: 69800 only include docking module, get inquiry for SBS full plate recapper and pipetting station.

The picture only for show workflow



Cryogenic Vials CAPPING & DECAPPING

Product Feature

- It is suitable for kinds of caps, diameter of 10-22/19-33mm, Automatically checked cap diameter
- The number of thread turns is adjustable and accuracy is 1/360 turn.
- The speed is 180~240rpm, and the opening time :1.5s.
- 4.3 inch LCD touch screen.
- 240V power supply, suitable for all kinds of power supply, safe operation.

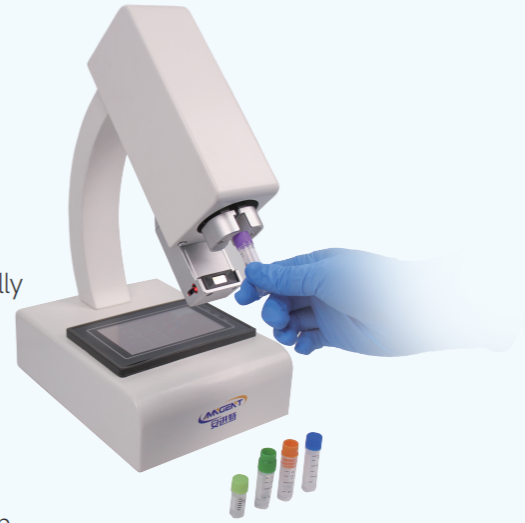

Order No.	Accuracy	Speed	Opening time	Packaging Specifications
695000	1/360 turn	180~240rpm	1.5s	1set/carton

Low-temperature Label Printers & Labels

Product Feature

- Thermal printer, resolution 300DPI.
- 3.5-inch color display panel.
- Low temperature labels : -86 degree labels and -196 degrees liquid nitrogen labels ok offer
- Low temperature labels are resistant to chemicals and solvents.
- Customization



Description	Order No.	Size	Temperature	Packaging Specifications
Low-temperature Label Printers	RT6100	—	—	1set/carton
Ribbon	910000	300m	—	1roll/carton
Low Temperature Label	920200	25.5*9.5mm Circle diameter9.5mm	-86°C	3000pcs/carton
Low Temperature Label	950200-1	30*20mm	-86°C	5000pcs/carton
Liquid Nitrogen Label	920201	25.5*9.5mm Circle diameter9.5mm	-196°C	3000pcs/carton

Sample Management Systems



- Login interface sample view, sample management, space management, approval, alarm management, system management, user settings, help information and other functions are clear at a glance.

- The system can visually display the storage containers and equipment in the bacteria bank, and display the graphical interface according to the storage structure of refrigerator-freezer rack-cryoboxes - cryogenic tube



- The system supports the view of storage containers, related operation logs of strain samples, and information change records through the page to ensure the integrity of data records of samples in the library and facilitate the use and traceability of samples.

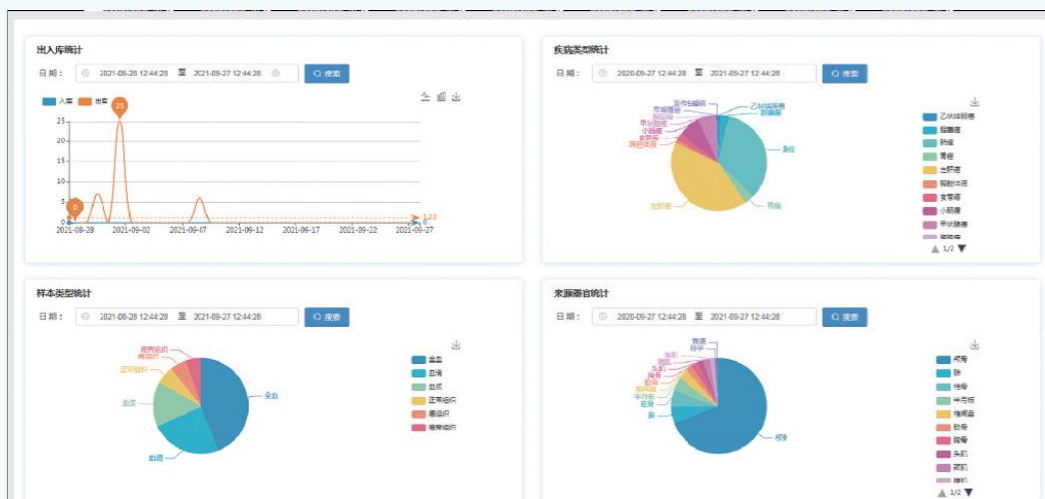

- System supports the user in accordance with the annual, quarterly, and monthly for the relevant amount in the library statistics, according to the sample we related information such as type, name, the custom of fields such as statistics, perspective display icon.

CONTACT US

ZHEJIANG RONGDA BIOTECHNOLOGY CO., LTD.

Tel: 0576-84080099

Website: www.rongda-bio.com

Address: Building 1, No. 999, Beiyuan Road, Xinqian street,
HuangyanArea, Taizhou City, Zhejiang Province, China

