

FOCUS ON LIFE SCIENCES CONSUMABLES



IVD Consumables Solutions

ZHEJIANG RONGDA BIOTECHNOLOGY CO., LTD.

INTRODUCTION

Zhejiang Rongda Biotechnology Co., Ltd. was established in 2018. Our company's headquarter is located in Huangyan, Taizhou, an economically developed and scenic eastern coastal area in Zhejiang Province. We serve our customers with a science-based and quality-oriented spirit. Our company has a strong professional R&D team. At the same time, we have long-term cooperation with well-known domestic universities and scientific research institutions, and signed the contract of new products development and reagent experiments.

We adhere to the belief of "providing high-quality services for bioscience" and found the AMNGENT brand, focusing on cell culture, molecular biological consumables, biological sample library construction, safety management and the development and production of Class I and Class II diagnostic reagents. We continue to invest in high-end production equipment in the industry and introduce professional process technicians to form a new scientific management team. Our products have passed ISO9001, ISO13485, CE and other quality system certifications. AMNGENT continues to grow and develop, and our products are exported to companies in more than 80 countries and regions such as the United States and the European Union.

For the early-stage design and development of molds, our company also has a high-quality, professional and persistent team that makes full use of modern CAD/CAM design and the capabilities of a comprehensive CNC machining center to manufacture high-quality medical consumables and various molds.



DIRECTORY

Screw cap micro tubes -lower cap ,with O-Ring.....	01
Screw cap micro tubes-Hinged cap, with O-Ring.....	05
Screw cap micro tubes-lower cap, without O-Ring.....	07
Screw cap micro tubes-High cap ,with O-ring.....	09
Reagent bottle -wide mouth	12
Media bottle.....	16
Disposable Samples tube	19
Reagent reservior	21
Deep plate.....	23
Hamilton automatic tips.....	25
Tecan automatic tips	27
Beckman automatic tips.....	29
Salivary collector	31

Screw cap micro tubes - quality concept

all tubes have undergone a number of tests.

Having passed these defined test procedures, the screw cap micro tubes have been certified as follows:

- ✔ **Sterile**
- ✔ **Pyrogen-free/endotoxin-free**
- ✔ **Non-cytotoxic**
- ✔ **CE**

We guarantee that the following limits will not be

- ▶ **Sterility validated according to the ISO 11137 series of standards**
- ▶ **Pyrogens/endotoxins < 0.01 EU/tube**
- ▶ **Non-cytotoxic in accordance with the ISO 10993 series of standards**



Screw cap micro tubes -lower cap with O-Ring

Feature

- Medical Grade Material: USP Biological Reactivity test report ,USP Plastic Class VI grade
- Non-Cytotoxicity
- RNase & Dnase free
- Pyrogen /Endotoxin free
- Heavy metal-free
- Sterile
- Standard 100,000 clean workshop production
- Temperature range: -86 to 121 °C (-186 to 250 °F)
- **CE**



*Above mentioned can provide third-party reports or associated product reports





- Sarstedet version lower cap line.
- 0.5ml , 1.5ml, 2.0ml for options
- Cap color for options, easy for clarify sample
- Cap new technical : Rotary automatic stripping mold, smooth match with tube and without damping feeling
- Cap bottom design : Gas seal production technology,no leakage under stronger pressure.



- Tube design with skirted base and knurling ,suitable for automatic filling.
- O-ring cap increases cap security (IATA tested)
Sealing : under -90Kpa ,15mins testing. 40°C constant temperature test
- Comply with the biocompatibility test report
- Strong chemical tolerance to acids, bases and alcohols

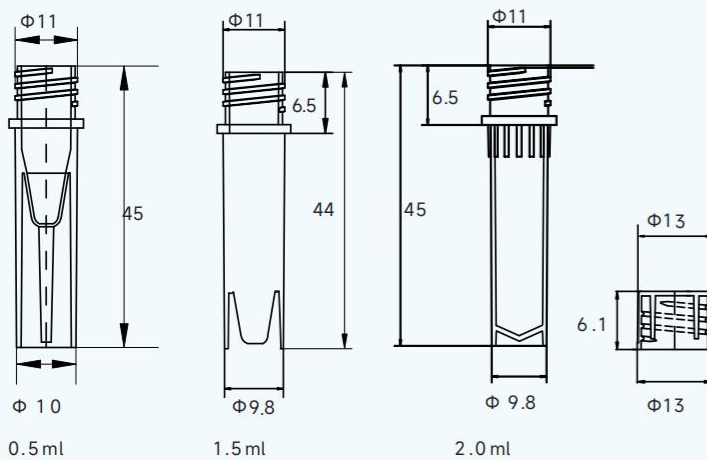





Ordering information



Screw cap micro tubes — lower cap only

Order No.	Color	Sterile	Non-enzyme	Packing	Picture
630000/-R/-B/-Y/-G	Clear/Clear Red/Clear blue/ Clear yellow/Clear green	×	✓	500pcs/bag 10bags/case	
633000/-R/-B/-Y/-G	Clear/Clear Red/Clear blue/ Clear yellow/Clear green	✓	✓	500pcs/bag 10bags/case	
63000X [X=1,2,3,4,5,6,7,8]	Solid red /green/blue/yellow/ purple/orange/white/brown	×	✓	500pcs/bag 10bags/case	
63300X [X=1,2,3,4,5,6,7,8]	Solid red /green/blue/yellow/ purple/orange/white/brown	✓	✓	500pcs/bag 10bags/case	

Screw cap micro tubes — **tube only**

Order No.	Volume	Color	Sterile	Non-enzyme	Packing	Picture
630050/51	0.5ml	clear/brown	X	✓	500pcs/bag 10bags/case	
633050/51	0.5ml	clear/brown	✓	✓	500pcs/bag 10bags/case	
630150/151	1.5ml	clear/brown	X	✓	500pcs/bag 10bags/case	
633150/151	1.5ml	clear/brown	✓	✓	500pcs/bag 10bags/case	
630200/201	2.0ml	clear/brown	X	✓	500pcs/bag 10bags/case	
633200/201	2.0ml	clear/brown	✓	✓	500pcs/bag 10bags/case	
630202	2.0ml	clear printing Writing Area And Scale Area	X	✓	500pcs/bag 10bags/case	
633202	2.0ml	clear printing Writing Area And Scale Area	✓	✓	500pcs/bag 10bags/case	

Screw cap micro tubes — **lower cap assembled ,with O-Ring**

Order No.	Volume	Color	Sterile	Non-enzyme	Packing	Picture
636050/51	0.5ml	clear/brown	✓	✓	50pcs/bag 40bags/case	
636150/151	1.5ml	clear/brown	✓	✓	50pcs/bag 40bags/case	
636200/201	2.0ml	clear/brown	✓	✓	50pcs/bag 40bags/case	
637200	2.0ml	clear printing Writing Area And Scale Area	✓	✓	50pcs/bag 40bags/case	

Screw cap micro tubes --Hinged lower cap, with O-Ring

Feature

- Sarstedet version lower cap line. Hinged cap
- 0.5ml , 1.5ml, 2.0ml for options
- Cap color for options, easy for clarify sample
- O-ring cap increases cap security (IATA tested)
- Sealing : under -90Kpa ,15mins testing. 40°C constant temperature

test









Ordering information

Screw cap micro tubes — lower cap only

Order No.	Color	Sterile	Non-enzyme	Packing	Picture
630500/-R/-B/-Y/-G	Clear/Clear Red/Clear blue/ Clear yellow/Clear green	X	✓	500pcs/bag 10bags/case	
633500/-R/-B/-Y/-G	Clear/Clear Red/Clear blue/ Clear yellow/Clear green	✓	✓	500pcs/bag 10bags/case	
63050X [X=1,2,3,4,5,6,7,8]	Solid red /green/blue/yellow/ purple/orange/white/brown	X	✓	500pcs/bag 10bags/case	
63350X [X=1,2,3,4,5,6,7,8]	Solid red /green/blue/yellow/ purple/orange/white/brown	✓	✓	500pcs/bag 10bags/case	

Screw cap micro tubes — lower cap assembled ,with O-Ring

Order No.	Color	Volume	Sterile	Non-enzyme	Packing	Picture
638050/-R/-B/-Y/-G	Clear/Clear Red/Clear blue/ Clear yellow/Clear green	0.5ml	✓	✓	50pcs/bag 40bags/case	
638050-X [X=1,2,3,4,5,6,7]	Solid red /green/blue/yellow/ purple/orange/white	0.5ml	✓	✓	50pcs/bag 40bags/case	
638051	brown	0.5ml	✓	✓	50pcs/bag 40bags/case	
638150/-R/-B/-Y/-G	Clear/Clear Red/Clear blue/ Clear yellow/Clear green	1.5ml	✓	✓	50pcs/bag 40bags/case	
638150-X [X=1,2,3,4,5,6,7]	Solid red /green/blue/yellow/ purple/orange/white	1.5ml	✓	✓	50pcs/bag 40bags/case	
638151	brown	1.5ml	✓	✓	50pcs/bag 40bags/case	
638200/-R/-B/-Y/-G	Clear/Clear Red/Clear blue/ Clear yellow/Clear green	2.0ml	✓	✓	50pcs/bag 40bags/case	
638200-X [X=1,2,3,4,5,6,7]	Solid red /green/blue/yellow/ purple/orange/white	2.0ml	✓	✓	50pcs/bag 40bags/case	
638201	brown	2.0ml	✓	✓	50pcs/bag 40bags/case	
639200	clear printing Writing Area And Scale Area	2.0ml	✓	✓	50pcs/bag 40bags/case	

Screw cap micro tubes -lower cap, without O-Ring

Feature

- Tube material and function same with microtube lower cap with O-ring
- O-ring cap increases cap security (IATA tested)
- Comply with the biocompatibility test report
- Strong chemical tolerance to acids, bases and alcohols



Ordering information

Screw cap micro tubes — lower cap no silicon ring

Order No.	Color	Sterile	Non-enzyme	Packing
640000	clear	X	✓	500pcs/bag 10bags/case
640001	clear red	X	✓	500pcs/bag 10bags/case
640002	clear blue	X	✓	500pcs/bag 10bags/case
640003	clear yellow	X	✓	500pcs/bag 10bags/case
640004	clear green	X	✓	500pcs/bag 10bags/case
643000	clear	✓	✓	500pcs/bag 10bags/case
643001	clear red	✓	✓	500pcs/bag 10bags/case
643002	clear blue	✓	✓	500pcs/bag 10bags/case
643003	clear yellow	✓	✓	500pcs/bag 10bags/case
643004	clear green	✓	✓	500pcs/bag 10bags/case

Screw cap micro tubes — lower cap assembled ,without O-Ring

Order No.	Volume	Color	Sterile	Non-enzyme	Packing
640200	2.0ml	clear	X	✓	500pcs/bag 10bags/case
643200	2.0ml	clear	✓	✓	500pcs/bag 10bags/case

Screw cap micro tubes -high cap , with O-Ring, Axygen line

Feature

- Medical Grade Material: USP Biological Reactivity test report ,USP Plastic Class VI grade
- Non-Cytotoxicity
- Temperature range: -86 to 121 °C (-186 to 250 °F)
- Axygenap line.
- 0.5ml , 1.5ml, 2.0ml for options
- Cap color for options, easy for clarify sample
- O-ring cap increases cap security (IATA tested)
- Sealing : under -90Kpa ,15mins testing. 40°C constant temperature test
- Comply with the biocompatibility test report
- Strong chemical tolerance to acids, bases and alcohols

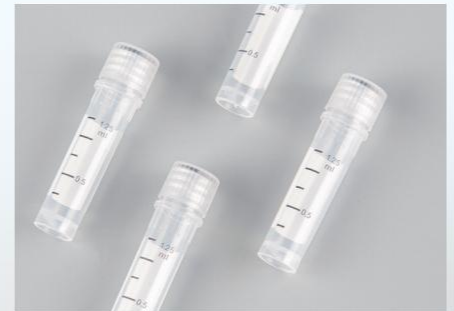





Ordering information





Screw cap micro tubes — High cap only

Order No.	Color	Sterile	Non-enzyme	Packing	Picture
610000/-R/-B/-Y/-G	Clear/Clear Red/Clear blue/ Clear yellow/Clear green	X	✓	500pcs/bag 10bags/case	
613000/-R/-B/-Y/-G	Clear/Clear Red/Clear blue/ Clear yellow/Clear green	✓	✓	500pcs/bag 10bags/case	
61000X [X=1,2,3,4,5,6,7]	Solid red /green/blue/yellow/ purple/orange/white	X	✓	500pcs/bag 10bags/case	
61300X [X=1,2,3,4,5,6,7]	Solid red /green/blue/yellow/ purple/orange/white	✓	✓	500pcs/bag 10bags/case	
620000	brown	X	✓	500pcs/bag 10bags/case	
623000	brown	✓	✓	500pcs/bag 10bags/case	

Screw cap micro tubes — tube only

Order No.	容量	Color	Sterile	Non-enzyme	Packing	Picture
610050/51	0.5ml	clear/brown	X	✓	500pcs/bag 10bags/case	
613050/51	0.5ml	clear/brown	✓	✓	500pcs/bag 10bags/case	
610150/151	1.5ml	clear/brown	X	✓	500pcs/bag 10bags/case	
613150/151	1.5ml	clear/brown	✓	✓	500pcs/bag 10bags/case	
610200/201	2.0ml	clear/brown	X	✓	500pcs/bag 10bags/case	
613200/201	2.0ml	clear/brown	✓	✓	500pcs/bag 10bags/case	
610202	2.0ml	clear printing Writing Area And Scale Area	X	✓	500pcs/bag 10bags/case	

Screw cap micro tubes — **Axygen cap assembled ,with O-Ring**

Order No.	Volume	Color	Sterile	Non-enzyme	Packing	Picture
616050/51	0.5ml	clear/brown	✓	✓	50pcs/bag 40bags/case	
616150/151	1.5ml	clear/brown	✓	✓	50pcs/bag 40bags/case	
616200/201	2.0ml	clear/brown	✓	✓	50pcs/bag 40bags/case	
617200	2.0m	clear printing Writing Area And Scale Area	✓	✓	50pcs/bag 40bags/case	

Dimension

unit:mm

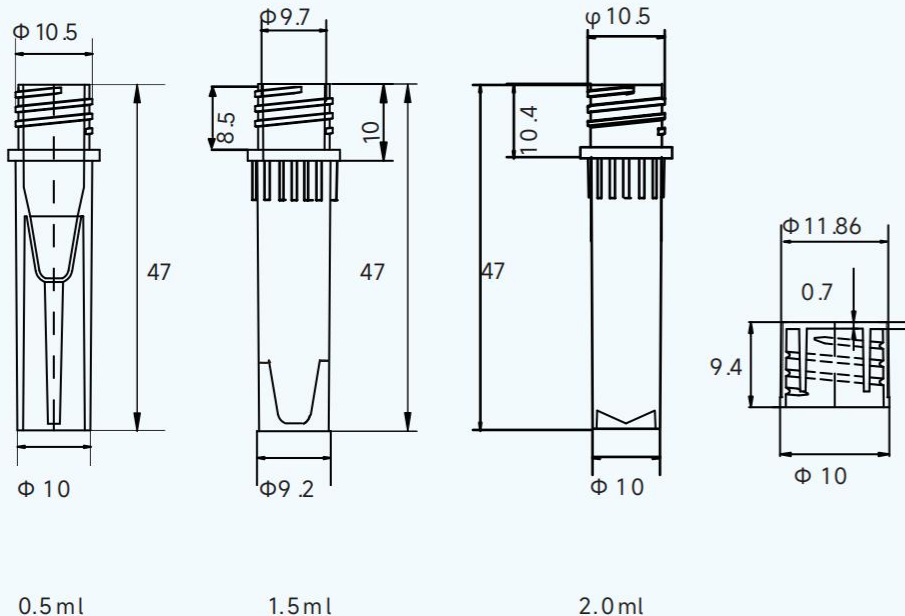

Reagent bottle

Feature

- Medical grade PP & HDPE
- RNase & Dnase free , Heavy metal-free
- Volume options:4ml、 8ml ,15ml ,30ml ,60ml, 125ml ,250ml ,500ml ,1000ml
- Bottle one step injection and blowing.
- Open and use without washing
- Cap: PP , bottle : PP & HDPE for options
- PP bottle temperature: High temperature and autoclaving, The embrittleness temperature of PP : zero degree, usually max. Use under 135 degree
HDPE bottle have better Low temperature storage performance,The embrittleness temperature of PP : -100 degree, usually max. Use under 120 degree



- Acid and alkali resistance: When storing oxidizing materials, organic solvents such as benzene rings, n-hexane and chlorinated hydrocarbons use HDPE bottle
- Toughness and impact resistance :PP bottles have excellent resistance to bending fatigue, but poor impact resistance (especially at low temperatures); HDPE bottle resistance is good,Low temperature storage is not easy to break after impact
- PP is more transparent than HDPE and is more conducive to observing the state of the material stored in the bottle
HDPE brown bottle 200-800nm full wavelength light protection; USP specifies light transmittance <10%
- Gas (N₂,O₂,CO₂) barrier :HDPE material is obviously superior to PP material

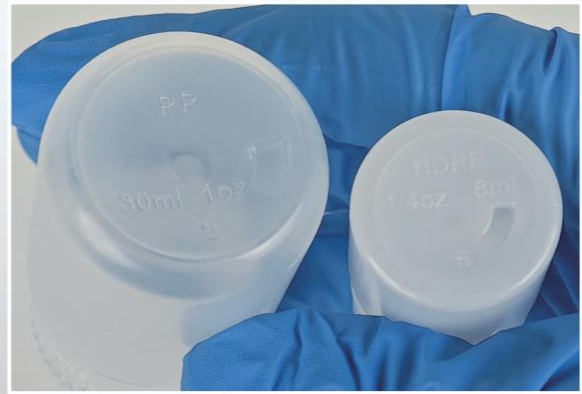

Ordering information

Reagent bottle -wide mouth — 4ml

Order No.	Material	Color	Sterile	Non-enzyme	Packing	Picture
5X0004	PP Cap, PP Bottle	clear	X=0, No Sterile; when X=5, Sterilized	✓	X=0, 200caps/bag, 200tubes/bag, 2000sets/case; X=5, 100pcs/bag, 10bags/case	
5X2004	PP Cap, HDPE Bottle	brown	X=0, No Sterile; when X=5, Sterilized	✓	X=0, 200caps/bag, 200tubes/bag, 2000sets/case; X=5, 100pcs/bag, 10bags/case	

Reagent bottle -wide mouth — 8ml

Order No.	Material	Color	Sterile	Non-enzyme	Packing	Picture
5X0008	PP Cap, PP Bottle	clear	X=0, No Sterile; when X=5, Sterilized	✓	X=0, 100caps/bag, 100tubes/bag, 1000sets/case; X=5, 20pcs/bag, 20bags/case	
5X1008	PP Cap, HDPE Bottle	Natural color	X=0, No Sterile; when X=5, Sterilized	✓	X=0, 100caps/bag, 100tubes/bag, 1000sets/case; X=5, 20pcs/bag, 20bags/case	
5X2008	PP Cap, HDPE Bottle	brown	X=0, No Sterile; when X=5, Sterilized	✓	X=0, 100caps/bag, 100tubes/bag, 1000sets/case; X=5, 20pcs/bag, 20bags/case	

Reagent bottle -wide mouth — 15ml

Order No.	Material	Color	Sterile	Non-enzyme	Packing	Picture
5X0015	PP Cap, PP Bottle	clear	X=0, No Sterile; when X=5, Sterilized	✓	X=0, 100caps/bag, 100tubes/bag, 1000sets/case; X=5, 20pcs/bag, 20bags/case	
5X1015	PP Cap, HDPE Bottle	Natural color	X=0, No Sterile; when X=5, Sterilized	✓	X=0, 100caps/bag, 100tubes/bag, 1000sets/case; X=5, 20pcs/bag, 20bags/case	
5X2015	PP Cap, HDPE Bottle	brown	X=0, No Sterile; when X=5, Sterilized	✓	X=0, 100caps/bag, 100tubes/bag, 1000sets/case; X=5, 20pcs/bag, 20bags/case	

Reagent bottle -wide mouth — 30ml

Order No.	Material	Color	Sterile	Non-enzyme	Packing	Picture
5X0030	PP Cap, PP Bottle	clear	X=0, No Sterile; when X=5, Sterilized	✓	X=0, 100caps/bag, 100tubes/bag, 1000sets/case; X=5, 20pcs/bag, 20bags/case	
5X1030	PP Cap, HDPE Bottle	Natural color	X=0, No Sterile; when X=5, Sterilized	✓	X=0, 100caps/bag, 100tubes/bag, 1000sets/case; X=5, 20pcs/bag, 20bags/case	
5X2030	PP Cap, HDPE Bottle	brown	X=0, No Sterile; when X=5, Sterilized	✓	X=0, 100caps/bag, 100tubes/bag, 1000sets/case; X=5, 20pcs/bag, 20bags/case	

Reagent bottle -wide mouth — 60ml

Order No.	Material	Color	Sterile	Non-enzyme	Packing	Picture
5X0060	PP Cap, PP Bottle	clear	X=0, No Sterile; when X=5, Sterilized	✓	X=0, 50caps/bag, 50tubes/bag, 500sets/case; X=5, 10pcs/bag, 20bags/case	
5X1060	PP Cap, HDPE Bottle	Natural color	X=0, No Sterile; when X=5, Sterilized	✓	X=0, 50caps/bag, 50tubes/bag, 500sets/case; X=5, 10pcs/bag, 20bags/case	
5X2060	PP Cap, HDPE Bottle	brown	X=0, No Sterile; when X=5, Sterilized	✓	X=0, 50caps/bag, 50tubes/bag, 500sets/case; X=5, 10pcs/bag, 20bags/case	

Reagent bottle -wide mouth — 125ml

Order No.	Material	Color	Sterile	Non-enzyme	Packing	Picture
5X0125	PP Cap, PP Bottle	clear	X=0, No Sterile; when X=5, Sterilized	✓	X=0, 25caps/bag, 25tubes/bag, 250sets/case; X=5, 10pcs/bag, 10bags/case	
5X1125	PP Cap, HDPE Bottle	Natural color	X=0, No Sterile; when X=5, Sterilized	✓	X=0, 25caps/bag, 25tubes/bag, 250sets/case; X=5, 10pcs/bag, 10bags/case	
5X2125	PP Cap, HDPE Bottle	brown	X=0, No Sterile; when X=5, Sterilized	✓	X=0, 25caps/bag, 25tubes/bag, 250sets/case; X=5, 10pcs/bag, 10bags/case	

Reagent bottle -wide mouth — 250ml

Order No.	Material	Color	Sterile	Non-enzyme	Packing	Picture
5X0250	PP Cap, PP Bottle	clear	X=0, No Sterile; when X=5, Sterilized	✓	X=0, 20caps/bag, 20tubes/bag, 200sets/case; X=5, 10pcs/bag, 10bags/case	
5X1250	PP Cap, HDPE Bottle	Natural color	X=0, No Sterile; when X=5, Sterilized	✓	X=0, 20caps/bag, 20tubes/bag, 200sets/case; X=5, 10pcs/bag, 10bags/case	
5X2250	PP Cap, HDPE Bottle	brown	X=0, No Sterile; when X=5, Sterilized	✓	X=0, 20caps/bag, 20tubes/bag, 200sets/case; X=5, 10pcs/bag, 10bags/case	

Reagent bottle -wide mouth — 500ml

Order No.	Material	Color	Sterile	Non-enzyme	Packing	Picture
5X0500	PP Cap, PP Bottle	clear	X=0, No Sterile; when X=5, Sterilized	✓	X=0, 10caps/bag, 10tubes/bag, 100sets/case; X=5, 5pcs/bag, 10bags/case	
5X1500	PP Cap, HDPE Bottle	Natural color	X=0, No Sterile; when X=5, Sterilized	✓	X=0, 10caps/bag, 10tubes/bag, 100sets/case; X=5, 5pcs/bag, 10bags/case	
5X2500	PP Cap, HDPE Bottle	brown	X=0, No Sterile; when X=5, Sterilized	✓	X=0, 10caps/bag, 10tubes/bag, 100sets/case; X=5, 5pcs/bag, 10bags/case	

Reagent bottle -wide mouth — 1000ml

Order No.	Material	Color	Sterile	Non-enzyme	Packing	Picture
5X1001	PP Cap, PP Bottle	clear	X=0, No Sterile; when X=5, Sterilized	✓	X=0, 5caps/bag, 5tubes/bag, 100sets/case; X=5, 5pcs/bag, 10bags/case	
5X1101	PP Cap, HDPE Bottle	Natural color	X=0, No Sterile; when X=5, Sterilized	✓	X=0, 5caps/bag, 5tubes/bag, 100sets/case; X=5, 5pcs/bag, 10bags/case	
5X1201	PP Cap, HDPE Bottle	brown	X=0, No Sterile; when X=5, Sterilized	✓	X=0, 5caps/bag, 5tubes/bag, 100sets/case; X=5, 5pcs/bag, 10bags/case	

Media Bottle

Feature

- Medical grade PETG
- High clear
- Rectangle shape, easy for hold and shipping
- E-Beam sterile, DNase & Rnase free, Non-endotoxin
- Temperature range: -86 to 60 °C (-186 to 140 °F)



- Cap : Rotary production process , easy and smooth match with bottle.
- Bottle : one step injection and blowing. No need wash and open use directly
- Clear and accurate scale, range 0.1mm









Volume Range

Nominal (ml)	Extreme deviation(ml)	Average(ml)
0-250	+6 -4	≥ 0
500	+8 -5	≥ 0
1000	+11 -6	≥ 0



Ordering information

Media Bottle

Order No.	Volume	Material	Sterile	Non-enzyme	Packing	Picture
590005	5ml	PETG	✓	✓	100pcs/bag, 5bags/case	
590010	10ml	PETG	✓	✓	100pcs/bag, 5bags/case	
590030	30ml	PETG	✓	✓	40pcs/bag, 7bags/case	
590060	60ml	PETG	✓	✓	40pcs/bag, 5bags/case	
590125	125ml	PETG	✓	✓	24pcs/bag, 4bags/case	
590250	250ml	PETG	✓	✓	30pcs/bag, 2bags/case	
590500	500ml	PETG	✓	✓	24pcs/bag, 2bags/case	
591000	1000ml	PETG	✓	✓	12pcs/bag, 4bags/case	

Dimension

unit:mm

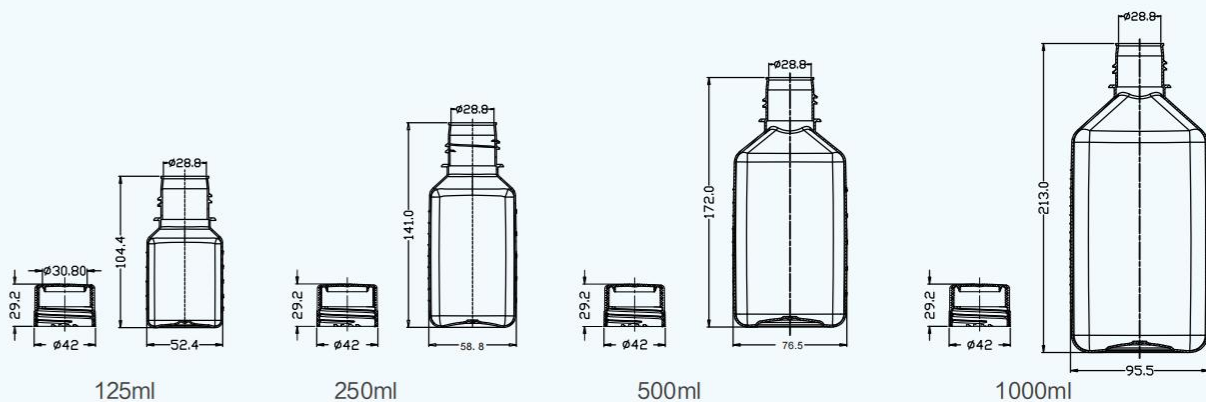

Sample tubes

Feature

- Medical grade PP tube, Cap PE
- 5ml, 6ml, 10ml, 20ml ,30ml for options
- DNase & Rnase free, Non-endotoxin, Heavy metal free
- -80Kpa test
- E-beam sterile

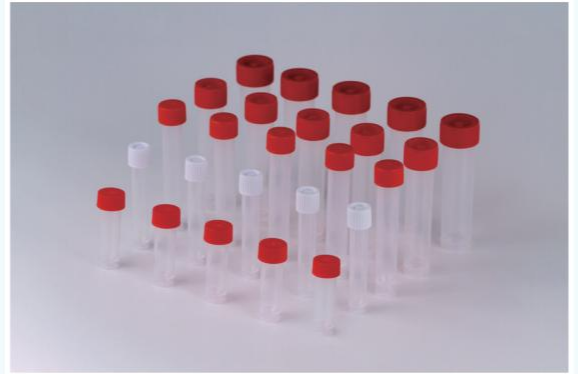

Dimension

unit:mm

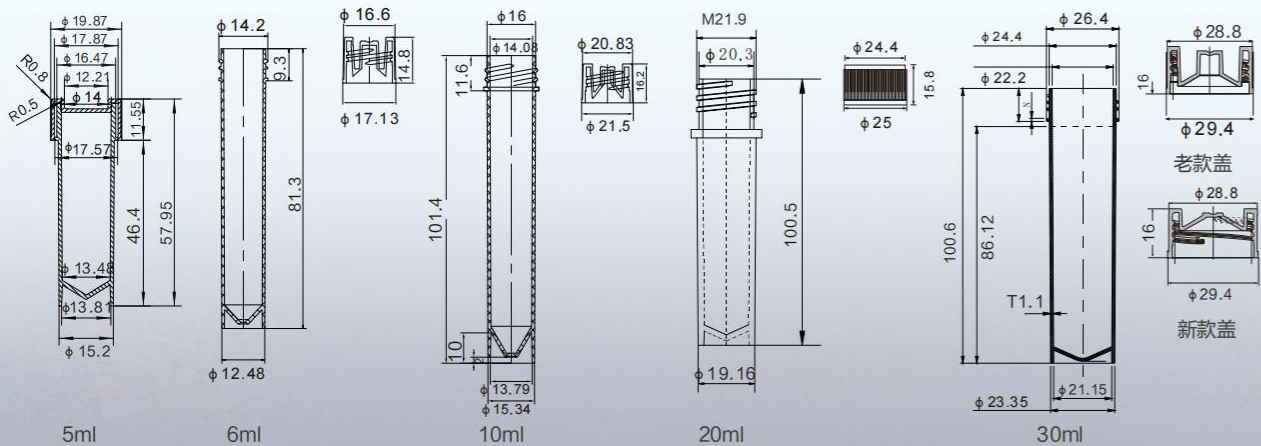

Ordering information

Sample tubes — 5ml

Order No.	Scale on tube	Non-enzyme	Sterile	Packing	Picture
650005	X	✓	X	500caps/bag,500tubes/bag, 1000sets/case	
650105	X	✓	✓	25pcs/bags,500pcs/case	

Sample tubes — 6ml

Order No.	Scale on tube	Non-enzyme	Sterile	Packing	Picture
650006	X	✓	X	500caps/bag,500tubes/bag, 1000sets/case	
650106	X	✓	✓	25pcs/bags,500pcs/case	

Sample tubes — 10ml

Order No.	Scale on tube	Non-enzyme	Sterile	Packing	Picture
650010	✓	✓	X	250caps/bag,250tubes/bag, 1000sets/case	
650110	✓	✓	✓	25pcs/bags,500pcs/case	

Sample tubes — 20ml

Order No.	Scale on tube	Non-enzyme	Sterile	Packing	Picture
650020	X	✓	X	200caps/bag,200tubes/bag, 1000sets/case	
650120	X	✓	✓	25pcs/bags,500pcs/case	

Sample tubes — 30ml

Order No.	Scale on tube	Non-enzyme	Sterile	Packing	Picture
650030	X	✓	X	200caps/bag,200tubes/bag, 800sets/case	
650130	X	✓	✓	25pcs/bags,500pcs/case	

Sample tubes — Sample tube holder

Order No.	Fit	Hole count	Packing
650121-R	5ml squat sample tube, 10ml sample tube	8*12=96 holes	50pcs/case
650020-R	20ml sample tube	6*8=48 holes	50pcs/case
650030-R	30ml sample tube	6*8=48 holes	50pcs/case

Reagent Reservoir

Feature

- SBS International standard, all products confirm to SBS international standard, are compatible with most of pipette workstations.
- Medical grade PP, imported virgin material
- More size and volume for options
- High temperature sterilization autoclavable at 121°C /15psi
- Non-enzyme, non-Pyrogen

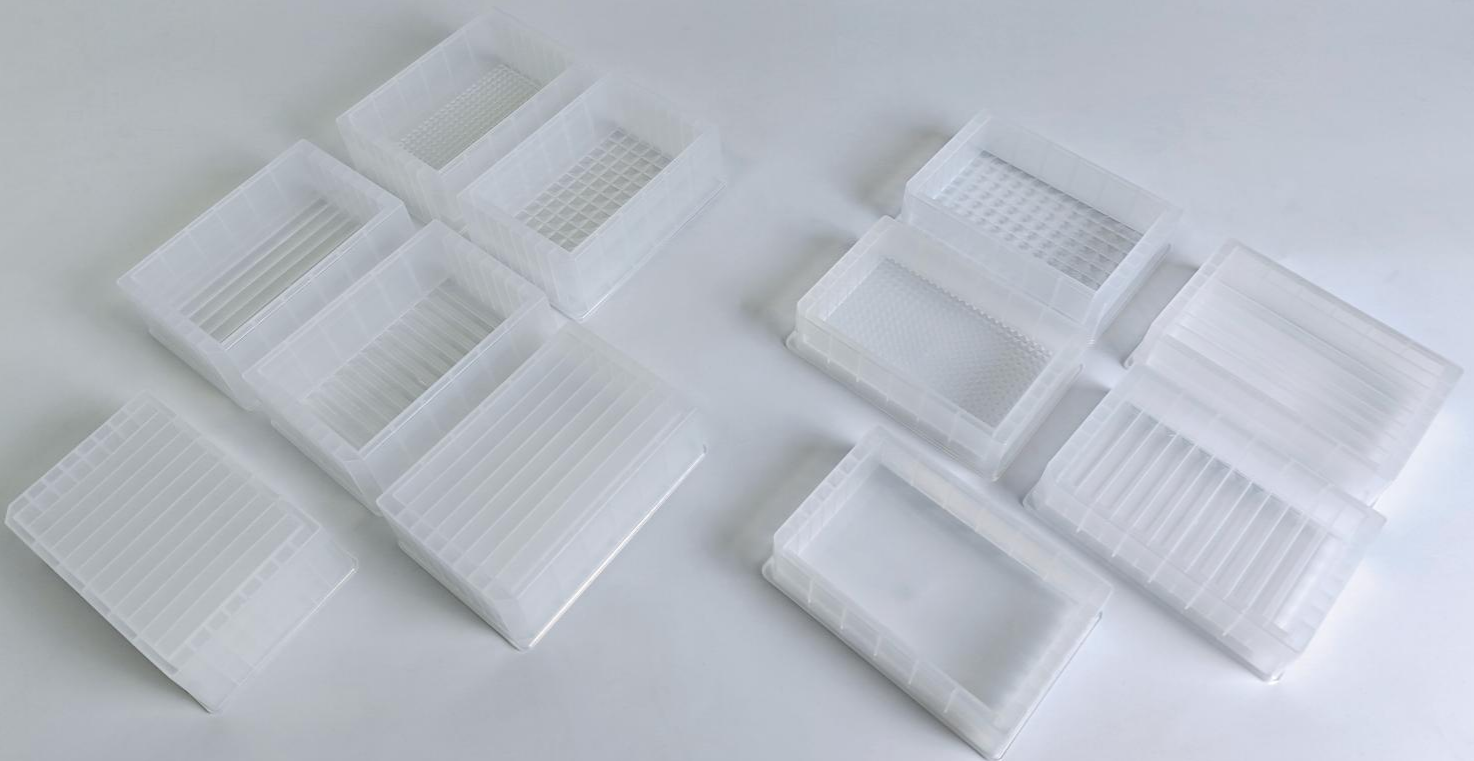

Ordering information

Reagent Reservoir — Middle Profile

Order No.	Channel	Volum	Size	Sterile &Non-enzyme	Packing
730001	Flat Channel--single Channe	190 mL	127.76X85.48X31.5 mm	✓	5 pcs/bag, 50 pcs/carton
730008	8 Channe--multi Channe	22 mL	127.76X85.48X31.5 mm	✓	5 pcs/bag, 50 pcs/carton
730012	12 Channel--multi Channe	15 mL	127.76X85.48X31.5 mm	✓	5 pcs/bag, 50 pcs/carton
730096	96 Channel --single Channe	195 mL	127.76X85.48X31.5 mm	✓	5 pcs/bag, 50 pcs/carton
730384	384 Channel --single Channe	185 mL	127.76X85.48X31.5 mm	✓	5 pcs/bag, 50 pcs/carton

Reagent Reservoir — High Profile

Order No.	Channel	Volum	Size	Sterile &Non-enzyme	Packing
732008	8 Channel --multi Channe	32 mL	127.76X85.48X44.5 mm	✓	5 pcs/bag, 50 pcs/carton
732012	12 Channe--multi Channe	22 mL	127.76X85.48X44.5 mm	✓	5 pcs/bag, 50 pcs/carton
731001	8 Channel --single Channe	290 mL	127.76X85.48X44.5 mm	✓	5 pcs/bag, 50 pcs/carton
731008	12 Channel --single Channe	290 mL	127.76X85.48X44.5 mm	✓	5 pcs/bag, 50 pcs/carton
731096	96 Channel --single Channe	290 mL	127.76X85.48X44.5 mm	✓	5 pcs/bag, 50 pcs/carton
731384	384 Channel --single Channe	290 mL	127.76X85.48X44.5 mm	✓	5 pcs/bag, 50 pcs/carton

Deep Well Plates

Feature

- Medical grade PP material
- Available in U bottom and V bottom
- Ok sterilized by high temperature and high pressure, matched with sealing film
- Compliant with SBS international standard

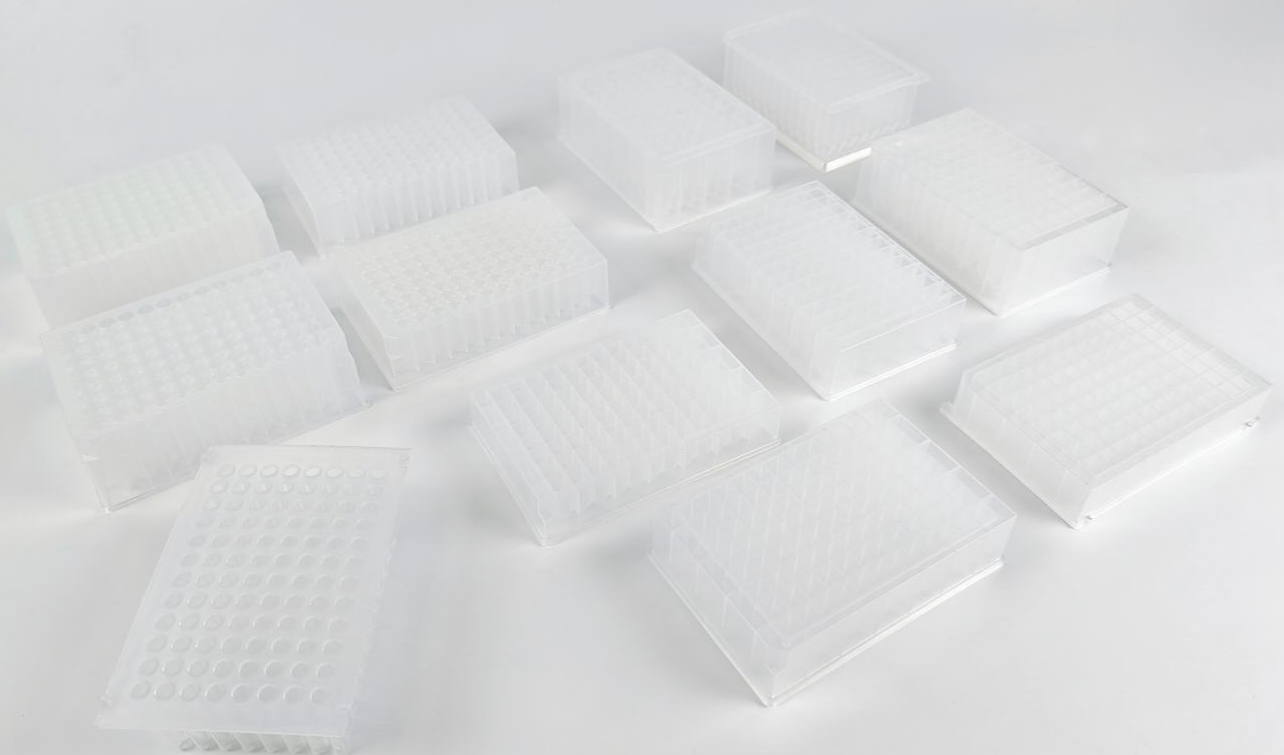

Ordering information

Deep Well Plate — 1.0ml

Order No.	Des.	Style	Sterile	Non-enzyme	Packing
671101	rectangle	V bottom	X	✓	5pcs/bag,10bags/case
671102	rectangle	U bottom	X	✓	5pcs/bag,10bags/case
673101	Round	V bottom	X	✓	5pcs/bag,10bags/case
673102	Round	U bottom	X	✓	5pcs/bag,10bags/case

Deep Well Plate — 1.6ml

Order No.	Des.	Style	Sterile	Non-enzyme	Packing
671601	rectangle	V bottom	X	✓	5pcs/bag,10bags/case
671602	rectangle	U bottom	X	✓	5pcs/bag,10bags/case

Deep Well Plate — 2.0ml

Order No.	Des.	Style	Sterile	Non-enzyme	Packing
673001	Round	V bottom	X	✓	5pcs/bag,10bags/case
673002	Round	U bottom	X	✓	5pcs/bag,10bags/case

Deep Well Plate — 2.2ml

Order No.	Des.	Style	Sterile	Non-enzyme	Packing
671001	rectangle	V bottom	X	✓	5pcs/bag,10bags/case
671002	rectangle	U bottom	X	✓	5pcs/bag,10bags/case
671003	rectangle	I-shaped board	X	✓	5pcs/bag,10bags/case

Rod Comb

Order No.	Des.	Sterile	Non-enzyme	Packing
672000	96-Strip Rod Comb	X	✓	10pcs/bag,10bags/case

Hamilton Automatic Pipette Tips

Feature

- Medical grade PP material
- Low absorption treatment, Reduction of residue
- Uniform resistance and CV values
- E-beam sterilization, DNase & RNase free, Non- pyrogen
- Hamilton automated tips for Hamilton series workstations



Ordering information

Hamilton automatic tips — no filter

Order No.	Volume	Color	Low absorption	Sterile & Non-enzyme	Packing
H490302	300 μ L	Black	✓	✓	96tips/rack,6racks/inner box,30racks/case
H491002	1000 μ L	Black	✓	✓	96tips/rack,5racks/inner box,25racks/case

Hamilton automatic tips — with filter

Order No.	Volume	Color	Low absorption	Sterile & Non-enzyme	Packing
H490303	300 μ L	Black	✓	✓	96tips/rack,6racks/inner box,30racks/case
H491003	1000 μ L	Black	✓	✓	96tips/rack,5racks/inner box,25racks/case

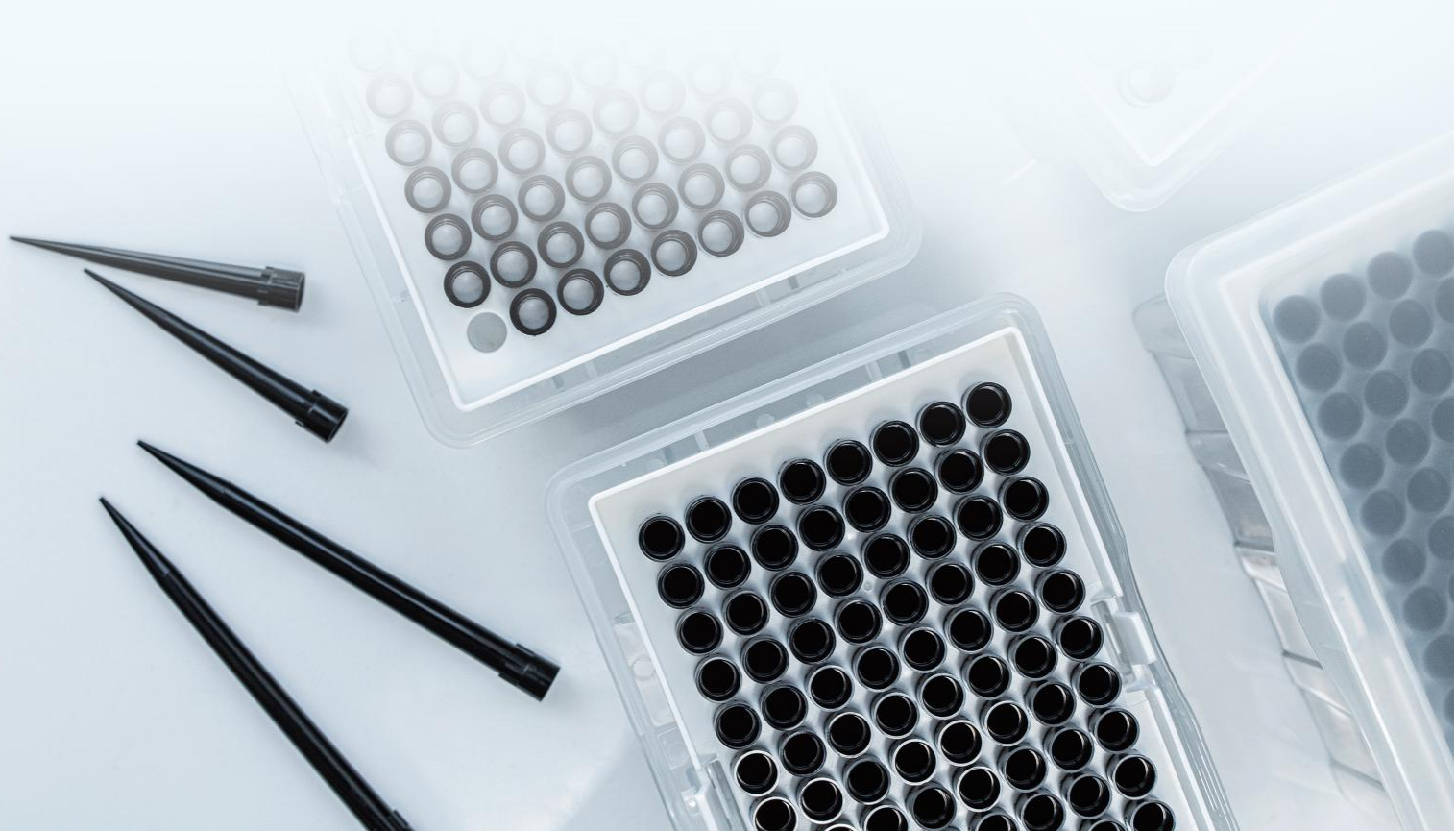

Tecan Automatic Pipette

Feature

- Medical grade PP material
- Low absorption treatment, Reduction of residue
- Uniform resistance and CV values
- E-beam sterilization, DNase & RNase free, Non- pyrogen
- Tecan automated tips for Tecan series workstations



Dimension

unit:mm

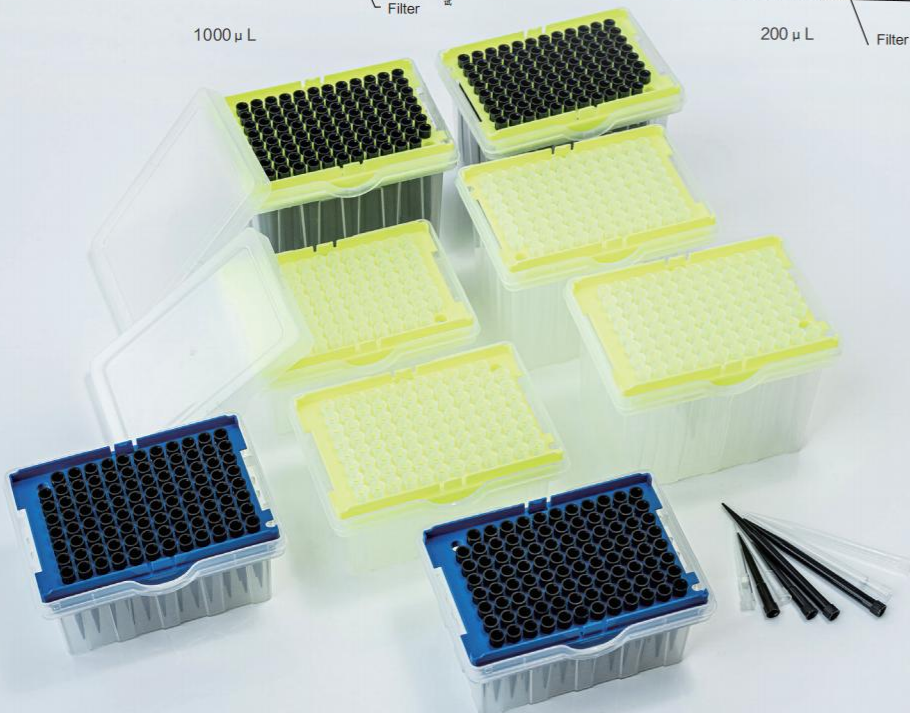
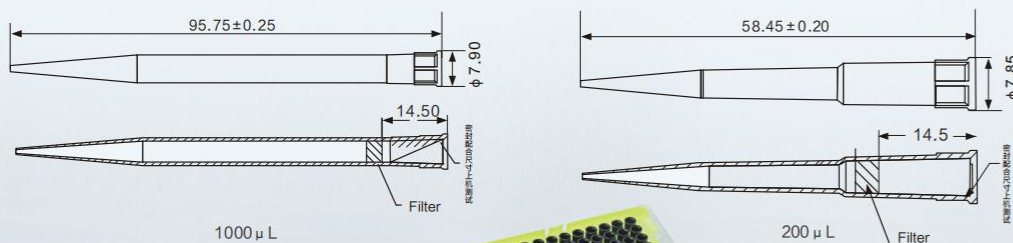

Ordering information

Tecan automatic tips — no filter

Order No.	Volume	Color	Low absorption	Sterile & Non-enzyme	Packing
T420020	20µL	clear	X	✓	96tips/rack,10racks/inner box,50racks/carton
T420022	20µL	Black	X	✓	96tips/rack,10racks/inner box,50racks/carton
T420050	50µL	clear	X	✓	96tips/rack,10racks/inner box,50racks/carton
T420052	50µL	Black	X	✓	96tips/rack,10racks/inner box,50racks/carton
T490200	200µL	clear	✓	✓	96tips/rack,6racks/inner box,30racks/carton
T490202	200µL	Black	✓	✓	96tips/rack,6racks/inner box,30racks/carton
T491000	1000µL	clear	✓	✓	96tips/rack,5racks/inner box,25racks/carton
T491002	1000µL	Black	✓	✓	96tips/rack,5racks/inner box,25racks/carton

Tecan automatic tips — with filter

Order No.	Volume	Color	Low absorption	Sterile & Non-enzyme	Packing
T420021	20µL	clear	X	✓	96tips/rack,10racks/inner box,50racks/carton
T420023	20µL	Black	X	✓	96tips/rack,10racks/inner box,50racks/carton
T420051	50µL	clear	X	✓	96tips/rack,10racks/inner box,50racks/carton
T420053	50µL	Black	X	✓	96tips/rack,10racks/inner box,50racks/carton
T490201	200µL	clear	✓	✓	96tips/rack,6racks/inner box,30racks/carton
T490203	200µL	Black	✓	✓	96tips/rack,6racks/inner box,30racks/carton
T491001	1000µL	clear	✓	✓	96tips/rack,5racks/inner box,25racks/carton
T491003	1000µL	Black	✓	✓	96tips/rack,5racks/inner box,25racks/carton

Beckman Automatic Pipette

Feature

- Medical grade PP material
- Low absorption treatment, Reduction of residue
- Uniform resistance and CV values
- E-beam sterilization, DNase & RNase free, Non- pyrogen
- Beckman automated tips are adapted to the Beckman series of workstations

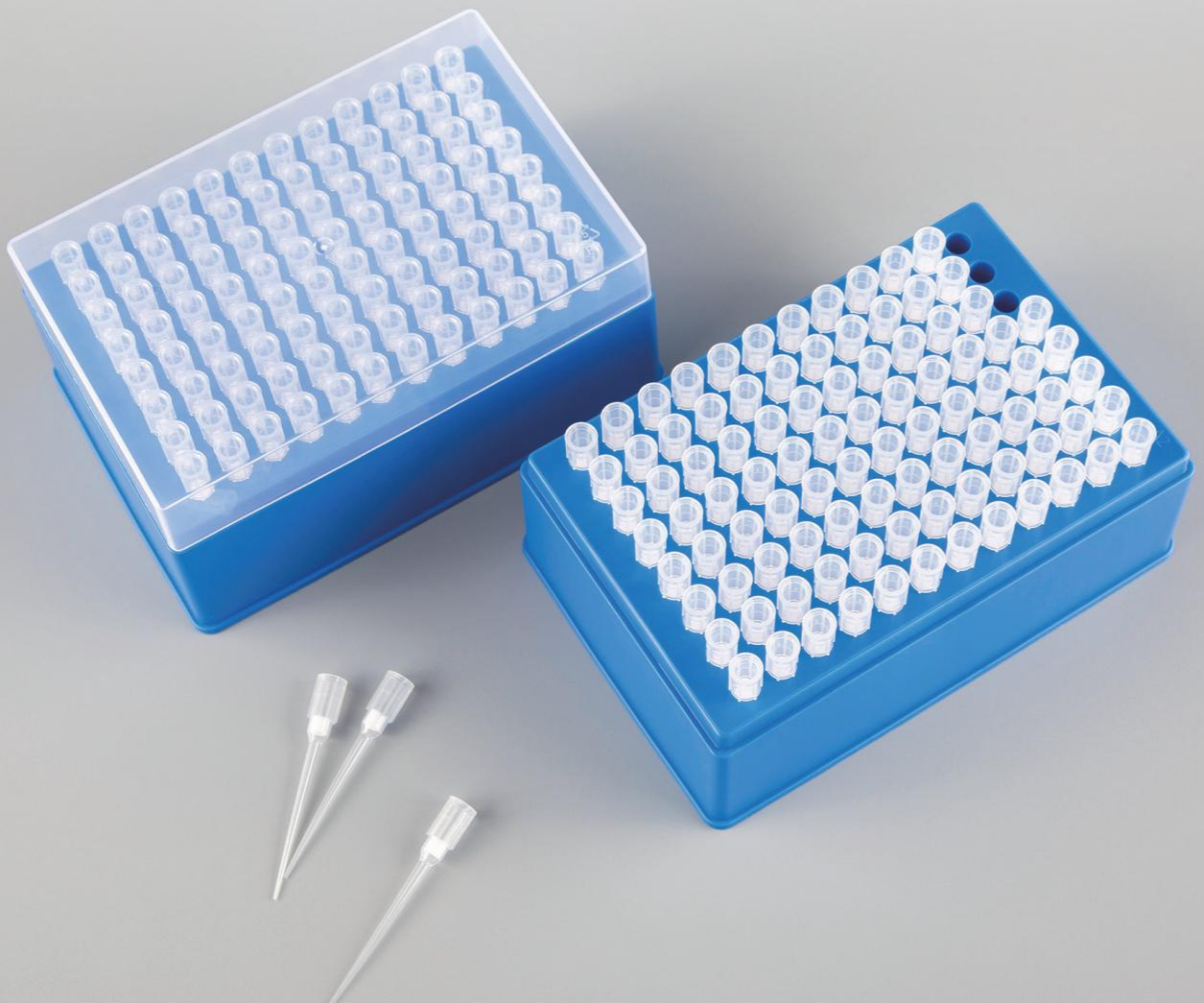

Ordering information

Beckman Automatic tips — no filter

Order No.	Volume	Color	Low absorption	Sterile & Non-enzyme	Packing
B490050	50µL	clear	X	✓	96tips/rack,, 50racks/carton
B490051	50µL	clear	✓	✓	96tips/rack,, 50racks/carton
B490250	250µL	clear	X	✓	96tips/rack,, 50racks/carton
B490251	250µL	clear	✓	✓	96tips/rack,, 50racks/carton

Beckman Automatic tips — with filter

Order No.	Volume	Color	Low absorption	Sterile & Non-enzyme	Packing
B490052	50µL	clear	X	✓	96tips/rack,, 50racks/carton
B490053	50µL	clear	✓	✓	96tips/rack,, 50racks/carton
B490252	250µL	clear	X	✓	96tips/rack,, 50racks/carton
B490253	250µL	clear	✓	✓	96tips/rack,, 50racks/carton

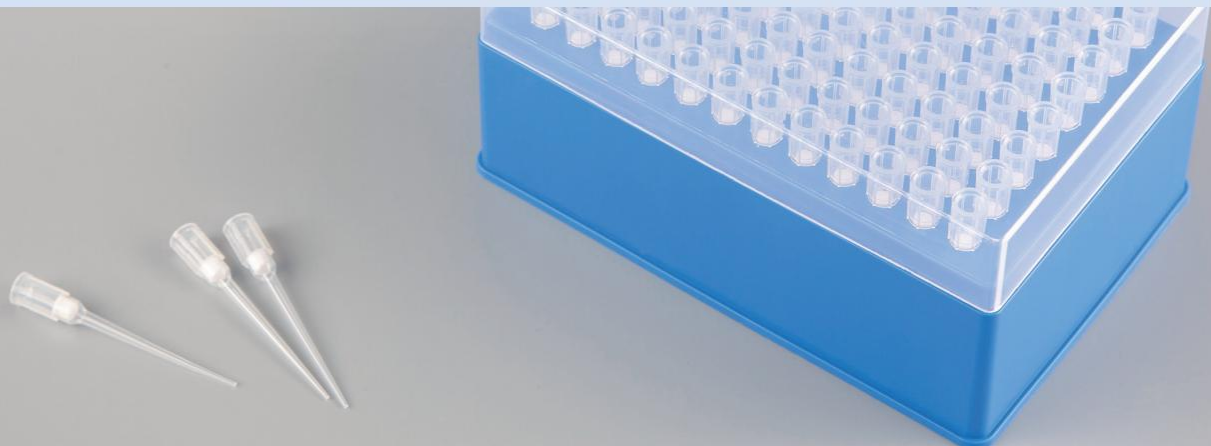

Saliva Collectors

Feature

- Medical grade PP material
- Ready to use saliva collectors, without liquid
- Safe, no pain, No cross contamination
- 5ml and 10ml tube for options
- Package : bag and blister pack for options



Ordering information

Saliva Collectors

Order No.	Volume	Scale	Sterile	Non-enzyme	Packing
652005	5ml	X	X	✓	1000sets/case
652011	10ml	✓	X	✓	1000sets/case
652505	5ml	X	X	✓	Blister box independent packaging,400sets/case
652505-s	5ml	X	✓	✓	Individule PE bag pack ,400sets/case
652511	10ml	✓	X	✓	Blister box independent packaging,275sets/case
652511-s	10ml	✓	✓	✓	Individule PE bag pack ,275sets/case
652000	--	--	X	✓	100pcs/bag, 1000pcs/carton

Dimension

unit:mm

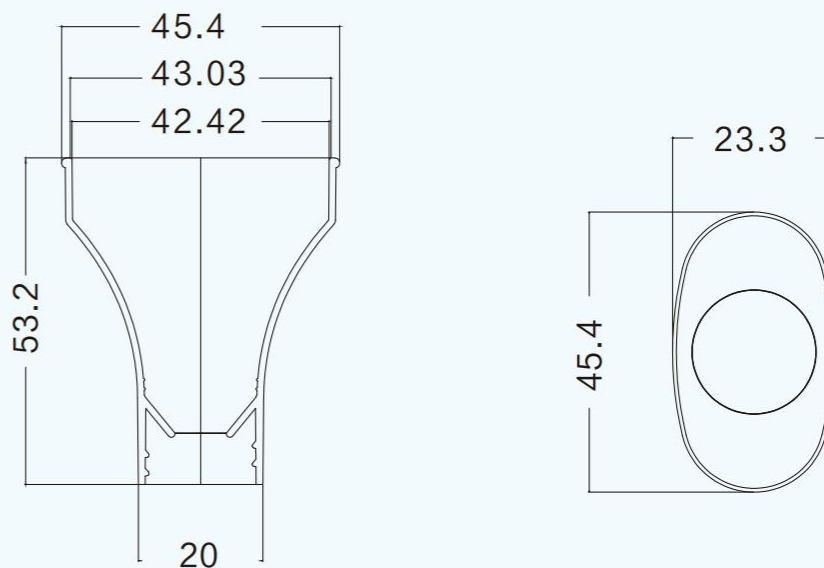

650006

CONTACT US

ZHEJIANG RONGDA BIOTECHNOLOGY CO., LTD.

Tel: 0576-84080099

Website: www.rongda-bio.com

Address: Building 1, No. 999, Beiyuan Road, Xinqian street,
HuangyanArea, Taizhou City, Zhejiang Province, China

