

FOCUS ON LIFE SCIENCES CONSUMABLES



# Laboratory Consumables Solutions

ZHEJIANG RONGDA BIOTECHNOLOGY CO., LTD.

# INTRODUCTION

Zhejiang Rongda Biotechnology Co., Ltd. was established in 2018. Our company's headquarter is located in Huangyan, Taizhou, an economically developed and scenic eastern coastal area in Zhejiang Province. We serve our customers with a science-based and quality-oriented spirit. Our company has a strong professional R&D team. At the same time, we have long-term cooperation with well-known domestic universities and scientific research institutions, and signed the contract of new products development and reagent experiments.

We adhere to the belief of "providing high-quality services for bioscience" and found the AMNGENT brand, focusing on cell culture, molecular biological consumables, biological sample library construction, safety management and the development and production of Class I and Class II diagnostic reagents. We continue to invest in high-end production equipment in the industry and introduce professional process technicians to form a new scientific management team. Our products have passed ISO9001, ISO13485, CE and other quality system certifications. AMNGENT continues to grow and develop, and our products are exported to companies in more than 80 countries and regions such as the United States and the European Union.

For the early-stage design and development of molds, our company also has a high-quality, professional and persistent team that makes full use of modern CAD/CAM design and the capabilities of a comprehensive CNC machining center to manufacture high-quality medical consumables and various molds.



# DIRECTORY

---

Centrifuge Tubes.....	01
Micro Centrifuge Tubes.....	04
Reagent Reservoir .....	06
Pipette Tips.....	08
Filter Pipette Tips.....	12
Pipette Tips Compatibility Chart.....	16
Pipette Tips For Rainin.....	17
5ml/10ml Pipette tips .....	20
Transfer Pipette .....	21
PCR Tubes .....	22
PCR Plates.....	23
Petri Dishes.....	24
Inoculating Loops & Needles.....	25
Cell Spreader .....	26
PC Conical Flasks .....	27
Gloves .....	28
Serological Pipettes .....	29
Cell Strainer .....	30
Cell Culture Dishes .....	31
Confocal Petri Dishes.....	32
Cell Culture Flasks .....	33
Cell Culture Plates.....	34
ELISA Plates.....	35

---

# Centrifuge Tubes

## Product Feature

- Medical Grade material : PP tube & HDPE cap. USP and DMF report available
- Endotoxin free ,Non-Cytotoxin
- DNase & RNase free
- Heavy Metal free
- Sterile available
- Standard 100,000 clean workshop producing
- **CE**

Above mentioned can provide third-party reports or Associated product report



- 15ml & 50ml conical bottom, 50ml flat bottom . Sterility, foam rack and bag pack for option
- Scale range : within  $\pm 0.1$
- Tube two-tone UV printing, Black scale mark+ white
- writing area, Clearly identify
- White writing area suitable for watercolor pen,Mark pen,Whiteboard writing,clearly and tidy



- Double threaded cap design for one-handed operation
- Cap rotational screw thread design ,match with tube smooth and easy, matching without damping feel
- Sealing : under-90kap ,15mins testing,40°C constant temperature test .Test reports are available
- Temperature range: -86 to 121 °C (-186F to 250 F)
- Max RCF:15ml 12000G 50ML 9500G



## Ordering information

### Centrifuge tubes — 15ml

Order No.	Bottom	Shape Max(*g)	Sterile	Non-enzyme	Packing	Product Images
220015	conical	12000	✓	✓	25pcs/bag 20bags/case	
221015	conical	12000	✓	✓	50pcs/rack 10racks/case	
225015	conical	12000	✗	✓	100caps/bag,100tubes/bag 500sets/case	

### Centrifuge tubes — 50ml

Order No.	Bottom	Shape Max(*g)	Sterile	Non-enzyme	Packing	Product Images
220250	Self-standing	9500	✓	✓	25pcs/bag 20bags/case	
220050	conical	9500	✓	✓	25pcs/bag 20bags/case	
221050	conical	9500	✓	✓	25pcs/rack 20racks/case	
225050	conical	9500	✗	✓	100caps/bag,100tubes/bag 500sets/case	

## Dimension

Unit: mm

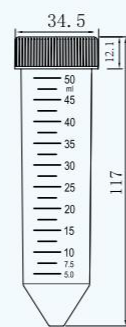

50ml  
220050/221050

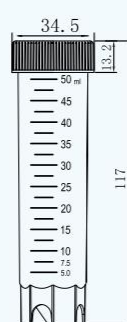

50ml  
220250



15ml  
220015/221015

# Micro Centrifuge Tubes

## Product Feature

- Medical Grade PP material
- Volume Options: 0.5ml 0.6ml 1.5ml 2.0ml
- Highly Transparent tube ,easy for observe. Clear Graduations and frosted marking area
- Special safe lock cap design ,easy for one hand open
- Flat cap easy for writing and label
- DNase & RNase free ,Non-endotoxin
- Temperature range: -86 to 121 °C (-186F to 250 F)
- Max RCF: 16000G

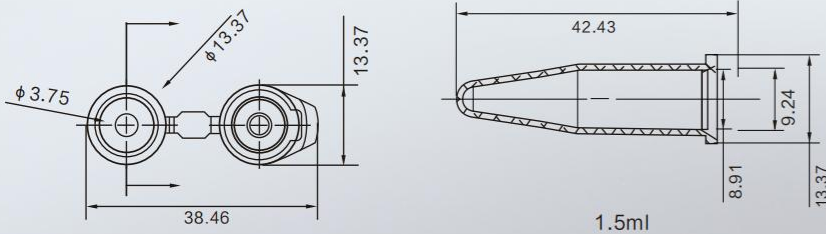

Dimensions=mm



## Ordering information

### Micro Centrifuge Tubes — 0.5ml

Order No.	Low absorption	Sterile	Non-enzyme	Packing	Product Images
240005	x	x	✓	500pcs/bag 10bags/case	

### Micro Centrifuge Tubes — 0.6ml

Order No.	Low absorption	Sterile	Non-enzyme	Packing	Product Images
240006	x	x	✓	500pcs/bag 10bags/case	
241006	✓	x	✓	500pcs/bag 10bags/case	
240106	x	✓	✓	50pcs/bag,10bags/box 4boxes/case	

### Micro Centrifuge Tubes — 1.5ml

Order No.	Low absorption	Sterile	Non-enzyme	Packing	Product Images
240015	x	x	✓	500pcs/bag 10bags/case	
241015	✓	x	✓	500pcs/bag 10bags/case	
240115	x	✓	✓	50pcs/bag,10bags/box 4boxes/case	

### Micro Centrifuge Tubes — 2.0ml

Order No.	Low absorption	Sterile	Non-enzyme	Packing	Product Images
240020	x	x	✓	500pcs/bag 10bags/case	
241020	✓	x	✓	500pcs/bag 10bags/case	
240120	x	✓	✓	50pcs/bag,10bags/box 4boxes/case	



# Reagent Reservoir

## Product Feature

- Color & Material Options : PS white and PVC clear
- Volume : 10ml, 25ml, 55ml , 100ml
- Package : white PS individual package,sterile, U shape bag easy for peel off  
PVC clear bulk pack



## Ordering information

Order No.	Volume	Material	Sterile	Non-enzyme	Style	Packing	Product Images
280010	10ml	PS	✓	✓	Individual	100pcs/case	
280025	25ml	PS	✓	✓	Individual	100pcs/case	
280050	55ml	PS	✓	✓	Individual	100pcs/case	
280100	100ml	PS	✓	✓	Individual	100pcs/case	
280051	55ml	PVC	✗	✗	Bulk	10pcs/bag 600bags/case	

## Dimension

Unit: mm

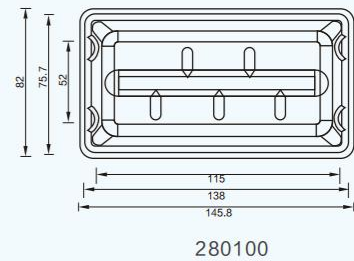
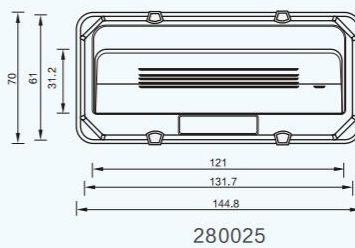
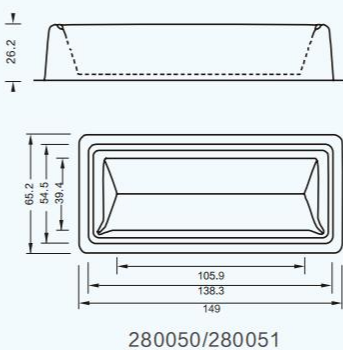

# Pipette Tips

## Product Feature

- Medical Grade PP
- Product options : Normal & Low retention
- Volume options : 10ul 10ul longer 200ul 300ul 1000ul 1250ul
- Suitable for : manual operation and Electronic pipettor
- DNase & RNase free ,Non-Pyrogen
- Package : Bag pack, Reload system, Rack pack for options
- Withstand 121°C high temperature and high pressure sterile



## Ordering information



### Pipette Tips — 10 $\mu$ L

Order No.	Color	Low retention	Sterile	Non-enzyme	Style	Packing	Product Images
430010	Transparent	x	x	✓	Bagged	1000tips/bag 10bags/case	
440010	Transparent	x	✓	✓	Racked	96tips/rack 50racks/case	
450010	Transparent	✓	✓	✓	Racked	96tips/rack 50racks/case	
460010	Transparent	x	x	✓	Stacked	96tips/stack 10stacks/inner 10inners/case	
470010	Transparent	✓	x	✓	Stacked	96tips/stack 10stacks/inner 10inners/case	

### Pipette Tips — 10 $\mu$ L Longer

Order No.	Color	Low retention	Sterile	Non-enzyme	Style	Packing	Product Images
430011	Transparent	x	x	✓	Bagged	500tips/bag 20bags/case	
440011	Transparent	x	✓	✓	Racked	96tips/rack 50racks/case	
450011	Transparent	✓	✓	✓	Racked	96tips/rack 50racks/case	
460011	Transparent	x	x	✓	Stacked	96tips/stack 10stacks/inner 10inners/case	
470011	Transparent	✓	x	✓	Stacked	96tips/stack 10stacks/inner 10inners/case	

Pipette Tips — 200 $\mu$ L

Order No.	Color	Low retention	Sterile	Non-enzyme	Style	Packing	Product Images
430201	Transparent	×	×	✓	Bagged	1000tips/bag 10bags/case	
440201	Transparent	×	✓	✓	Racked	96tips/rack 50racks/case	
430200	Transparent yellow	×	×	✓	Bagged	1000tips/bag 10bags/case	
440200	Transparent yellow	×	✓	✓	Racked	96tips/rack 50racks/case	
450200	Transparent yellow	✓	✓	✓	Racked	96tips/rack 50racks/case	
460200	Transparent yellow	×	×	✓	Stacked	96tips/stack 10stacks/inner 10inners/case	
470200	Transparent yellow	✓	×	✓	Stacked	96tips/stack 10stacks/inner 10inners/case	

Pipette Tips — 300 $\mu$ L

Order No.	Color	Low retention	Sterile	Non-enzyme	Style	Packing	Product Images
430301	Transparent	×	×	✓	Bagged	1000tips/bag 10bags/case	
440301	Transparent	×	✓	✓	Racked	96tips/rack 50racks/case	
460300	Transparent	×	×	✓	Stacked	96tips/stack 10stacks/inner 10inners/case	
470300	Transparent	✓	×	✓	Stacked	96tips/stack 10stacks/inner 10inners/case	

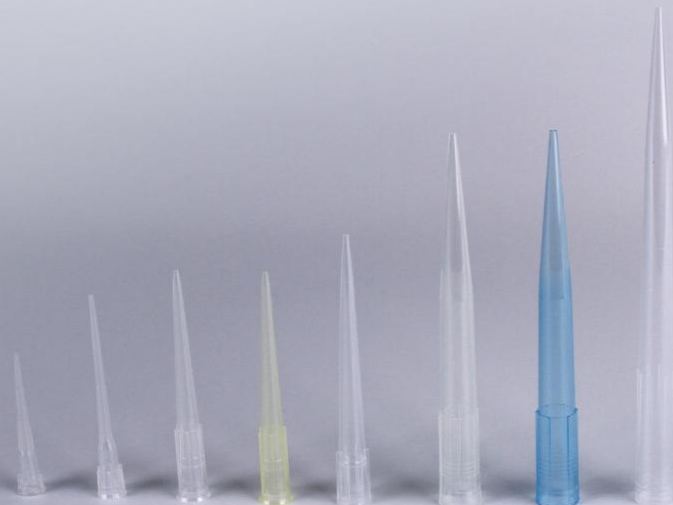

Pipette Tips — 1000 $\mu$ L

Order No.	Color	Low retention	Sterile	Non-enzyme	Style	Packing	Product Images
431001	Transparent	×	×	✓	Bagged	1000tips/bag 10bags/case	
441001	Transparent	×	✓	✓	Racked	96tips/rack 30racks/case	
431000	Transparent blue	×	×	✓	Bagged	1000tips/bag 10bags/case	
441000	Transparent blue	×	✓	✓	Racked	96tips/rack 30racks/case	
451000	Transparent blue	✓	✓	✓	Racked	96tips/rack 30racks/case	
461000	Transparent blue	×	×	✓	Stacked	96tips/stack 8stacks/inner 10inners/case	
471000	Transparent blue	✓	×	✓	Stacked	96tips/stack 8stacks/inner 10inners/case	

Pipette Tips — 1250 $\mu$ L

Order No.	Color	Low retention	Sterile	Non-enzyme	Style	Packing	Product Images
431250	Transparent	×	×	✓	Bagged	500tips/bag 10bags/case	
441250	Transparent	×	✓	✓	Racked	96tips/rack 30racks/case	
451250	Transparent	✓	✓	✓	Racked	96tips/rack 30racks/box	
461250	Transparent	×	×	✓	Stacked	96tips/stack 8stacks/inner 10inners/case	
471250	Transparent	✓	×	✓	Stacked	96tips/stack 8stacks/inner 10inners/case	



1250ul

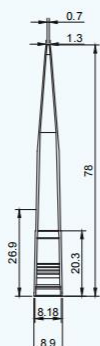

1000ul

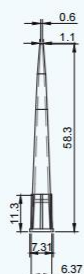

300ul

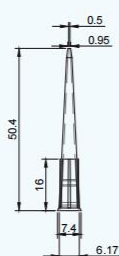

200ul



10ul Longer



10ul

Dimensions=mm

# Filter Pipette Tips

## Product Feature

---

- Medical Grade PP
- Product options : Normal & Low retention
- Volume options : 10ul 10ul longer 20ul 50ul 100ul 200ul 200ul longer 300ul 1000ul 1250ul
- DNase & RNase free ,Non-Pyrogen
- Package : Bag pack, Reload system, Rack pack for options



## Ordering information

### Filter Pipette Tips — 10 $\mu$ L

Order No.	Color	Low retention	Sterile	Non-enzyme	Style	Packing	Product Images
400010	Transparent	×	×	✓	Bagged	1000tips/bag 10bags/case	
420010	Transparent	×	✓	✓	Racked	96tips/rack 10racks/inner 50inners/case	
480010	Transparent	✓	✓	✓	Racked	96tips/stack 10racks/inner 50inners/case	

### Filter Pipette Tips — 10 $\mu$ L加长

Order No.	Color	Low retention	Sterile	Non-enzyme	Style	Packing	Product Images
400011	Transparent	×	×	✓	Bagged	500tips/bag 20bags/case	
420011	Transparent	×	✓	✓	Racked	96tips/rack 10racks/inner 50inners/case	
480011	Transparent	✓	✓	✓	Racked	96tips/rack 10racks/inner 50inners/case	

### Filter Pipette Tips — 20 $\mu$ L

Order No.	Color	Low retention	Sterile	Non-enzyme	Style	Packing	Product Images
400020	Transparent	×	×	✓	Bagged	1000tips/bag 10bags/case	
420020	Transparent	×	✓	✓	Racked	96tips/rack 10racks/inner 50inners/case	
480020	Transparent	✓	✓	✓	Racked	96tips/rack 10racks/inner 50inners/case	

### Filter Pipette Tips — 50 $\mu$ L

Order No.	Color	Low retention	Sterile	Non-enzyme	Style	Packing	Product Images
400050	Transparent	×	×	✓	Bagged	1000tips/bag 10bags/case	
420050	Transparent	×	✓	✓	Racked	96tips/rack 10racks/inner 50inners/case	
480050	Transparent	✓	✓	✓	Racked	96tips/rack 10racks/inner 50inners/case	



## Filter Pipette Tips — 100µL

Order No.	Color	Low retention	Sterile	Non-enzyme	Style	Packing	Product Images
400100	Transparent	×	×	✓	Bagged	1000tips/bag 10bags/case	
420100	Transparent	×	✓	✓	Racked	96tips/rack 10racks/inner 50inners/case	
480100	Transparent	✓	✓	✓	Racked	96tips/rack 10racks/inner 50inners/case	

## Filter Pipette Tips — 200µL

Order No.	Color	Low retention	Sterile	Non-enzyme	Style	Packing	Product Images
400200	Transparent	×	×	✓	Bagged	1000tips/bag 10bags/case	
420200	Transparent	×	✓	✓	Racked	96tips/rack 10racks/inner 50inners/case	
480200	Transparent	✓	✓	✓	Racked	96tips/rack 10racks/inner 50inners/case	

## Filter Pipette Tips — 200µL Longer

Order No.	Color	Low retention	Sterile	Non-enzyme	Style	Packing	Product Images
420201	Transparen	×	✓	✓	Racked	96tips/rack 6racks/inner 30inners/case	

## Filter Pipette Tips — 300µL

Order No.	Color	Low retention	Sterile	Non-enzyme	Style	Packing	Product Images
400300	Transparent	×	×	✓	Bagged	1000tips/bag 10bags/case	
420300	Transparent	×	✓	✓	Racked	96tips/rack 8racks/inner 40inners/case	
480300	Transparent	✓	✓	✓	Racked	96tips/rack 8racks/inner 40inners/case	

Filter Pipette Tips — 1000 $\mu$ L

Order No.	Color	Low retention	Sterile	Non-enzyme	Style	Packing	Product Images
401000	Transparent	×	×	✓	Bagged	1000tips/bag 10bags/case	
421000	Transparent	×	✓	✓	Racked	96tips/rack 6racks/inner 30inners/case	
481000	Transparent	✓	✓	✓	Racked	96tips/stack 6racks/inner 30inners/case	

Filter Pipette Tips — 1250 $\mu$ L

Order No.	Color	Low retention	Sterile	Non-enzyme	Style	Packing	Product Images
401250	Transparent	×	×	✓	Bagged	500tips/bag 10bags/case	
421250	Transparent	×	✓	✓	Racked	96tips/rack 6racks/inner 30inners/case	
481250	Transparent	✓	✓	✓	Racked	96tips/rack 6racks/inner 30inners/case	

## ◆ Dimension

Unit: mm

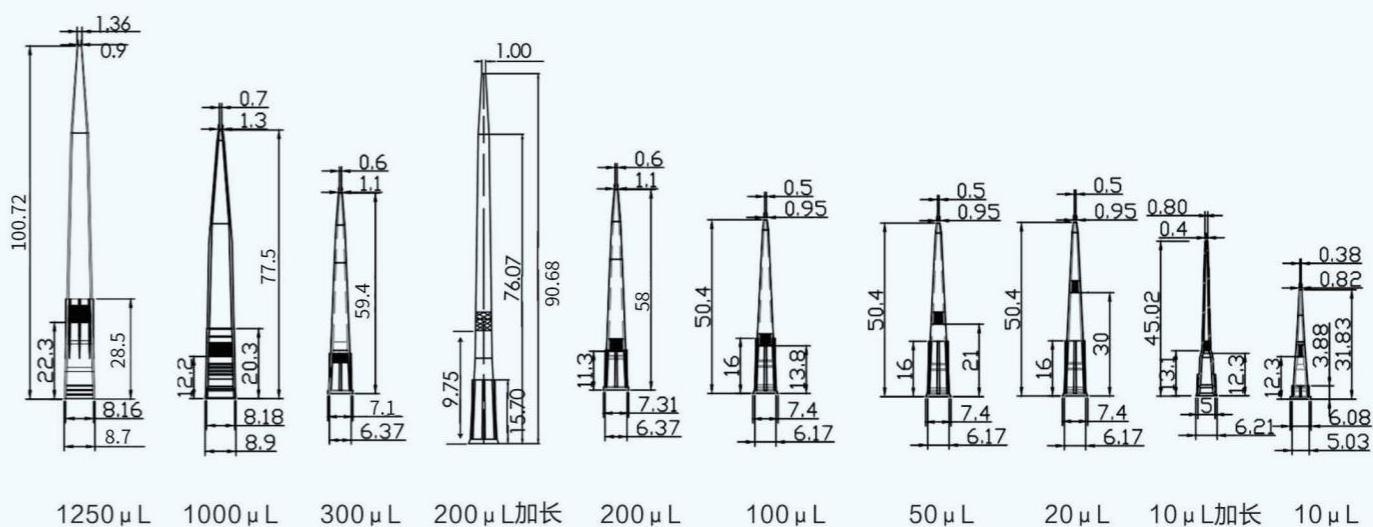

# Pipette Tips Compatibility Chart

## Compatibility Chart

BRAND	Specification	Universal Tips						Filter Tips								
		440010	440011	440200	440300	441000	441250	420010	420011	420020	420100	420200	420300	421000	421250	
Thermo	Single Channel	F3 series 1-10 $\mu$ L	✓	✓				✓	✓							
		F3 series 2-20 $\mu$ L			✓					✓	✓	✓	✓			
		F3 series 5-50 $\mu$ L			✓						✓					
		F3 series 10-100 $\mu$ L			✓						✓					
		F3 series 20-200 $\mu$ L			✓						✓	✓	✓			
		F3 series 100-1000 $\mu$ L					✓	✓							✓	✓
	F2 series 0.5-5 $\mu$ L	✓	✓													
	Multi Channel	F2 series 1-10 $\mu$ L	✓	✓				✓	✓							
	Multi Channel	F2 series multichannel 1-10 $\mu$ L	✓	✓				✓	✓							
Sartorius	Single Channel	proline series 0.1-2.5 $\mu$ L														
		proline series 0.5-10 $\mu$ L	✓	✓				✓	✓							
		proline series 2-20 $\mu$ L			✓					✓	✓					
		proline series 10-100 $\mu$ L			✓						✓					
		proline series 20-200 $\mu$ L			✓	✓					✓	✓	✓			
	proline series 100-1000 $\mu$ L					✓	✓						✓	✓		
	Multi Channel	0.5-10 $\mu$ L	✓	✓				✓	✓							
Bran	Single Channel	0.1-2.5 $\mu$ L	✓	✓				✓	✓							
		1-10 $\mu$ L	✓	✓				✓	✓							
		2-20 $\mu$ L			✓					✓	✓					
		10-100 $\mu$ L			✓						✓					
		20-200 $\mu$ L			✓	✓					✓	✓	✓			
		100-1000 $\mu$ L					✓	✓						✓	✓	

## Compatibility Chart

BRAND	Specification	Universal Tips						Filter Tips							
		440010	440011	440200	440300	441000	441250	420010	420011	420020	420100	420200	430300	421000	421250
Gilson	Single Channel	PN 2-20 $\mu$ L			✓					✓	✓				
		PN 10-100 $\mu$ L			✓					✓					
		PN 20-200 $\mu$ L			✓						✓	✓			
		PN 100-1000 $\mu$ L					✓	✓						✓	✓
Eppendorf	Single Channel	0.1-2.5 $\mu$ L	✓	✓				✓	✓						
		1-10 $\mu$ L	✓	✓				✓	✓						
		2-20 $\mu$ L			✓					✓	✓				
		10-100 $\mu$ L			✓					✓					
		20-200 $\mu$ L			✓	✓					✓	✓			
		Multi Channel	100-1000 $\mu$ L				✓	✓						✓	✓
	0.5-10 $\mu$ L		✓	✓					✓	✓					
	5-100 $\mu$ L				✓						✓				
	50-100 $\mu$ L				✓						✓				
	20-300 $\mu$ L				✓	✓						✓	✓		
		30-300 $\mu$ L			✓	✓					✓	✓			
		50-1200 $\mu$ L				✓	✓								
Dra gonia b	Single Channel	0.1-2.5 $\mu$ L	✓	✓				✓	✓						
		1-10 $\mu$ L	✓	✓				✓	✓						
		2-20 $\mu$ L			✓					✓	✓				
		10-100 $\mu$ L			✓					✓					
		20-200 $\mu$ L			✓	✓					✓	✓			
		100-1000 $\mu$ L				✓	✓						✓	✓	

# Pipette Tips For Rainin

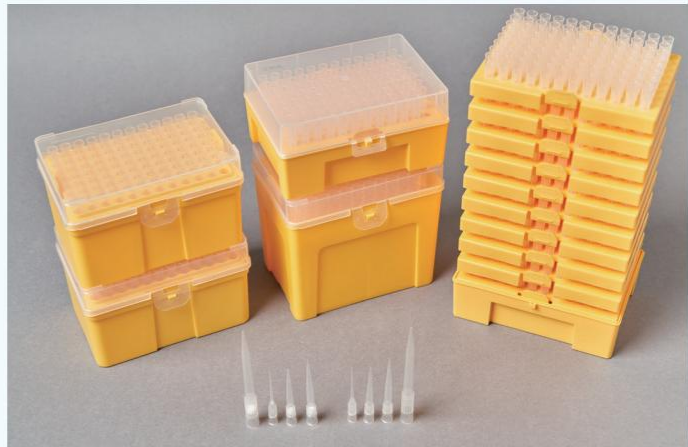

## Product Feature

- Medical Grade PP
- Suitable for LTS pipettor
- Product options : Normal & Low retention
- Volume options : 20ul 200ul 300ul 1000ul 1200ul
- DNase & RNase free ,Non-Pyrogen
- Package : Bag pack, Reload system, Rack pack for options



## Ordering information

### LTS Pipette Tips — 20μL

Order No.	Filter	Low retention	Sterile	Non-enzyme	Style	Packing	Product Images
R430020	No	X	X	✓	Bagged	500tips/bag 20bags/case	
R440020	No	X	✓	✓	Racked	96tip/rack 10rack/inner 5inner/case	
R450020	No	✓	✓	✓	Racked	96tip/rack 10rack/inner 5inner/case	
R460020	No	X	X	✓	Stacked	96tip/stack 10stacks/inner 10innners/case	
R400020	Yes	X	✓	✓	Bagged	500tips/bag 20bags/case	
R420020	Yes	X	✓	✓	Racked	96tip/rack 10rack/inner 5inner/case	
R480020	Yes	✓	✓	✓	Racked	96tip/rack 10rack/inner 5inner/case	

LTS Pipette Tips — 200 $\mu$ L

Order No.	Filter	Low retention	Sterile	Non-enzyme	Style	Packing	Product Images
R430200	No	×	×	✓	Bagged	1000tips/bag 10bags/case	
R440200	No	×	✓	✓	Racked	96tips/rack 10racks/inner 5inners/case	
R450200	No	✓	✓	✓	Racked	96tips/rack 10racks/inner 5inners/case	
R460200	No	×	×	✓	Stacked	96tips/stack 10stacks/inner 10inners/case	
R400200	Yes	×	✓	✓	Bagged	1000tips/bag 10bags/case	
R420200	Yes	×	✓	✓	Racked	96tips/rack 10racks/inner 5inners/case	
R480200	Yes	✓	✓	✓	Racked	96tips/rack 10racks/inner 5inners/case	

LTS Pipette Tips — 300 $\mu$ L

Order No.	Filter	Low retention	Sterile	Non-enzyme	Style	Packing	Product Images
R430300	No	×	×	✓	Bagged	1000tips/bag 10bags/case	
R440300	No	×	✓	✓	Racked	96tips/rack 10racks/inner 5inners/case	
R450300	No	✓	✓	✓	Racked	96tips/rack 10racks/inner 5inners/case	
R460300	No	×	×	✓	Stacked	96tips/stack 10stacks/inner 10inners/case	
R400300	Yes	×	✓	✓	Bagged	1000tips/bag 10bags/case	
R420300	Yes	×	✓	✓	Racked	96tips/rack 10racks/inner 5inners/case	
R480300	Yes	✓	✓	✓	Racked	96tips/rack 10racks/inner 5inners/case	

### LTS Pipette Tips — 1000µL

Order No.	Filter	Low retention	Sterile	Non-enzyme	Style	Packing	Product Images
R431000	No	×	×	✓	Bagged	1000tips/bag 5bags/case	
R441000	No	×	✓	✓	Racked	96tips/rack 10racks/inner 5inners/case	
R451000	No	✓	✓	✓	Racked	96tips/rack 10racks/inner 5inners/case	
R461000	No	×	×	✓	Stacked	96tips/stack 8stacks/inner 10inners/case	
R401000	Yes	×	✓	✓	Bagged	1000tips/bag 5bags/case	
R421000	Yes	×	✓	✓	Racked	96tips/rack 10racks/inner 5inners/case	
R481000	Yes	✓	✓	✓	Racked	96tips/rack 10racks/inner 5inners/case	

### LTS Pipette Tips — 1200µL

Order No.	Filter	Low retention	Sterile	Non-enzyme	Style	Packing
R431200	No	×	×	✓	Bagged	1000tips/bag 5bags/case
R441200	No	×	✓	✓	Racked	96tips/rack 10racks/inner 5inners/case
R451200	No	✓	✓	✓	Racked	96tips/rack 10racks/inner 5inners/case
R401200	Yes	×	×	✓	Bagged	1000tips/bag 5bags/case
R421200	Yes	×	✓	✓	Racked	96tips/rack 10racks/inner 5inners/case
R481200	Yes	✓	✓	✓	Racked	96tips/rack 10racks/inner 5inners/case

## Dimension

Unit: mm

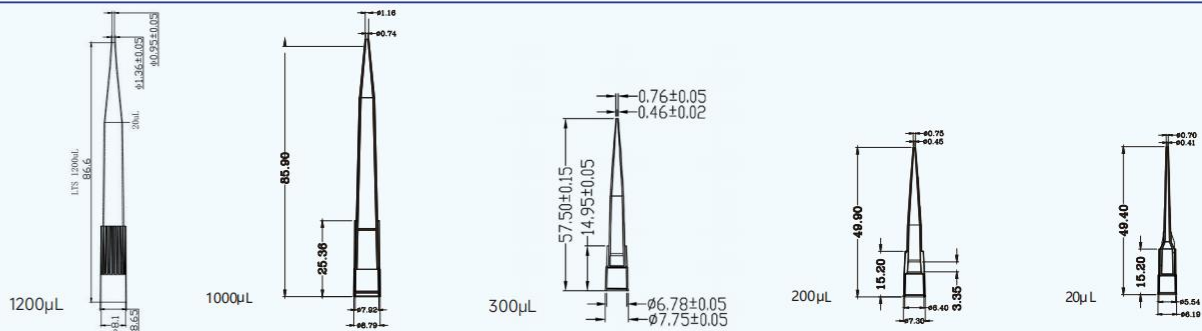

# 5ml/10ml Pipette Tips

## Product Feature

- Compatible with many pipettes brands
- Clear scale mark, transparent body and the volume can be visually confirmed
- No DNase, RNA enzyme, no pyrogen
- Can be sterilized under high pressure, with a temperature tolerance range of -80~121°C

Item No.	Volume	Color	Filter	Non-enzyme	Packing
6002005-D	5ml	Transparent	Without	✓	100pcs/bag,10 bags/case
6003005-D	5ml	Transparent	Without	✓	100pcs/bag,10 bags/case
6001005-D	5ml	Transparent	Without	✓	100pcs/bag,10 bags/case
6001010-D	10ml	Transparent	Without	✓	100pcs/bag,10 bags/case
6002010-D	10ml	Transparent	Without	✓	100pcs/bag,10 bags/case
6002005-H	5ml	Transparent	Without	✓	40pcs/rack,16 racks/case
6003005-H	5ml	Transparent	Without	✓	24pcs/rack,16 racks/case
6001005-H	5ml	Transparent	Without	✓	24pcs/rack,16 racks/case
6001010-H	10ml	Transparent	Without	✓	24pcs/rack,16 racks/case
6002010-H	10ml	Transparent	Without	✓	24pcs/rack,16 racks/case
7002005-H	5ml	Transparent	With filter	✓	40pcs/rack,16 racks/case
7003005-H	5ml	Transparent	With filter	✓	24pcs/rack,16 racks/case
7001005-H	5ml	Transparent	With filter	✓	24pcs/rack,16 racks/case
7001010-H	10ml	Transparent	With filter	✓	24pcs/rack,16 racks/case
7002010-H	10ml	Transparent	With filter	✓	24pcs/rack,16 racks/case

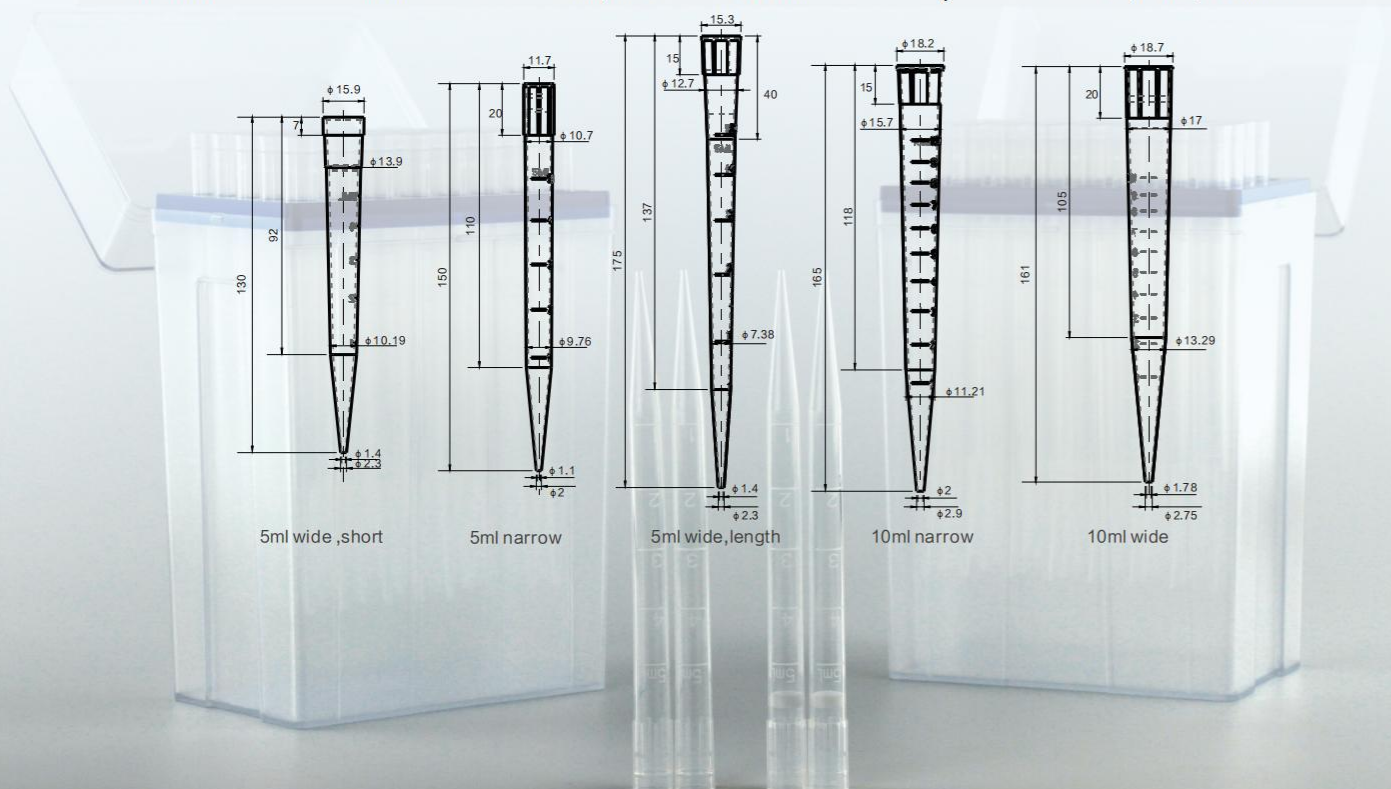

# Transfer Pipettes

## Product Feature

- High Quality PE material, high toughness, high transparency
- Tube Body and Bulk thickening design, easy for dropper and cell blowing
- Elastic suction pouch, Good Rebound recovery
- Slender and soft, Easy to transfer liquids quickly, instead of rubber dropper
- Sterile 15kg
- Pack : Plastic-paper individually packed and bulk packed



Item No.	Volume	Length	Sterile	Non-enzyme	Type	Packing
330001	1ml	159mm	×	×	Bulk	500pcs/rack, 2000pcs/case
330011	1ml	159mm	✓	✓	Individual	500pcs/rack, 2000pcs/case
330201	2ml	155mm	×	×	Bulk	500pcs/rack, 2000pcs/case
330211	2ml	155mm	✓	✓	Individual	500pcs/rack, 2000pcs/case
330301	3ml	160mm	×	×	Bulk	500pcs/rack, 2000pcs/case
330311	3ml	160mm	✓	✓	Individual	500pcs/rack, 2000pcs/case
330302	3ml extra length	185mm	×	×	Bulk	500pcs/rack, 2000pcs/case
330312	3ml extra length	185mm	✓	✓	Individual	500pcs/rack, 2000pcs/case

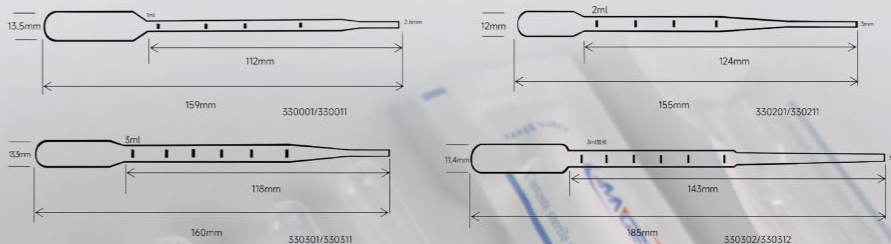



# PCR Tubes

## Product Feature

- Medical Grade PP
- Ultrathin tube, Extremely fast temperature conduction
- Flat cap design, suitable for real-time quantification PCR test
- Sealed design, Effectively avoid exploding cap problems
- DNase & RNase free, Non-Pyrogen
- Working temperature: -20degree -100degree, suitable for normal brand PCR machine, support for fully supported rotor
- Centrifugal force: 6000G

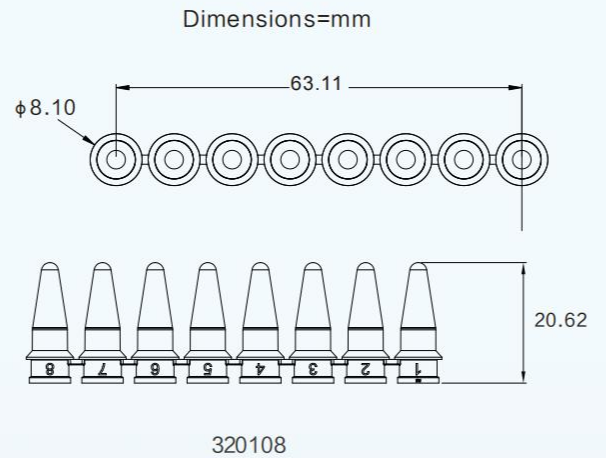

Order No.	Volume	Color	Color	Cap	Non-enzyme	Packing
310008	0.1ml,8-strip	Transparent	AXYGEN	Flat	✓	125pcs/rack, 10racks/case
310108	0.1ml,8-strip	White	AXYGEN	Flat	✓	125pcs/rack, 10racks/case
311008	0.1ml,8-strip	Transparent	Roche	Flat	✓	125pcs/rack, 10racks/case
311108	0.1ml,8-strip	White	Roche	Flat	✓	125pcs/rack, 10racks/case
320002	0.2ml,single	Transparent	General	Flat	✓	1000pcs/rack, 10racks/case
320108	0.2ml,8-strip	Transparent	AXYGEN	Flat	✓	125pcs/rack, 10racks/case
320128	0.2ml,8-strip	Transparent	Roche	Flat	✓	125pcs/rack, 10racks/case
320158	0.2ml,8-strip	Transparent	General	Convex	✓	125pcs/rack, 10racks/case

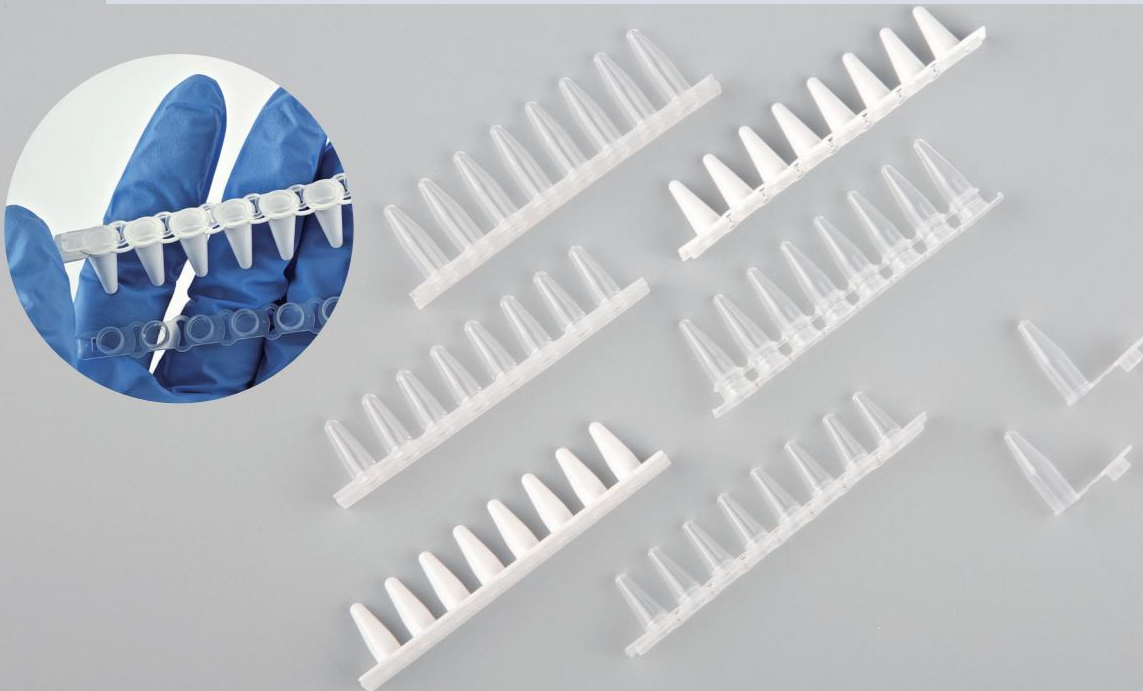

# PCR Plates

## Product Feature

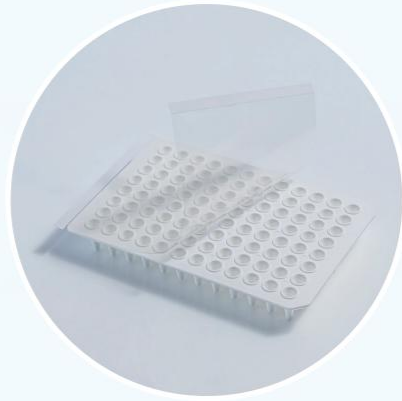

- 医疗级聚丙烯材质
- **超薄管壁**，极快温度传导
- 适用于实时荧光定量实验
- **无裙边、半裙边、全裙边**多款可选
- 板面平整，孔周凸起，便于封板膜粘贴
- 无DNase、RNase，无内毒素
- 封版膜采用医疗级聚丙烯材质
- 无自发荧光，保证实验准确性
- 压敏膜，提高实验方便性及光学数据准确性

Order No.	Volume	Color	Skirt	Type	Non-enzyme	Packing
310196	0.1ml	Transparent	Non-skirt	General	√	10pcs/bag, 50pcs/case
310096	0.1ml	Transparent	Half-skirt	Roche	√	10pcs/bag, 50pcs/case
313196	0.1ml	White	Non-skirt	General	√	10pcs/bag, 50pcs/case
313096	0.1ml	White	Half-skirt	Roche	√	10pcs/bag, 50pcs/case
310396	0.1ml	Transparent	Half-skirt	ABI	√	10pcs/bag, 50pcs/case
310596	0.1ml	Transparent	Full-skirt	Workstation	√	10pcs/bag, 50pcs/case
313596	0.1ml	White	Full-skirt	Workstation	√	10pcs/bag, 50pcs/case
320196	0.2ml	Transparent	Non-skirt	General	√	10pcs/bag, 50pcs/case
320096	0.2ml	Transparent	Half-skirt	Roche	√	10pcs/bag, 50pcs/case
323196	0.2ml	White	Non-skirt	General	√	10pcs/bag, 50pcs/case
323096	0.2ml	White	Half-skirt	Roche	√	10pcs/bag, 50pcs/case
320396	0.2ml	Transparent	Half-skirt	ABI	√	10pcs/bag, 50pcs/case
326000(sealing film)	—	Transparent	—	—	√	100pcs/case
326010(sealing film)	—	Transparent	—	—	√	100pcs/case
326020(sealing film)	—	Transparent	—	—	√	100pcs/case

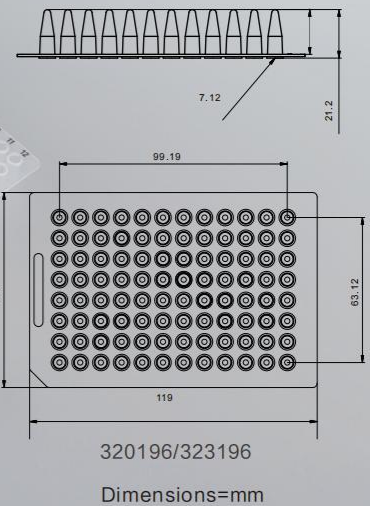
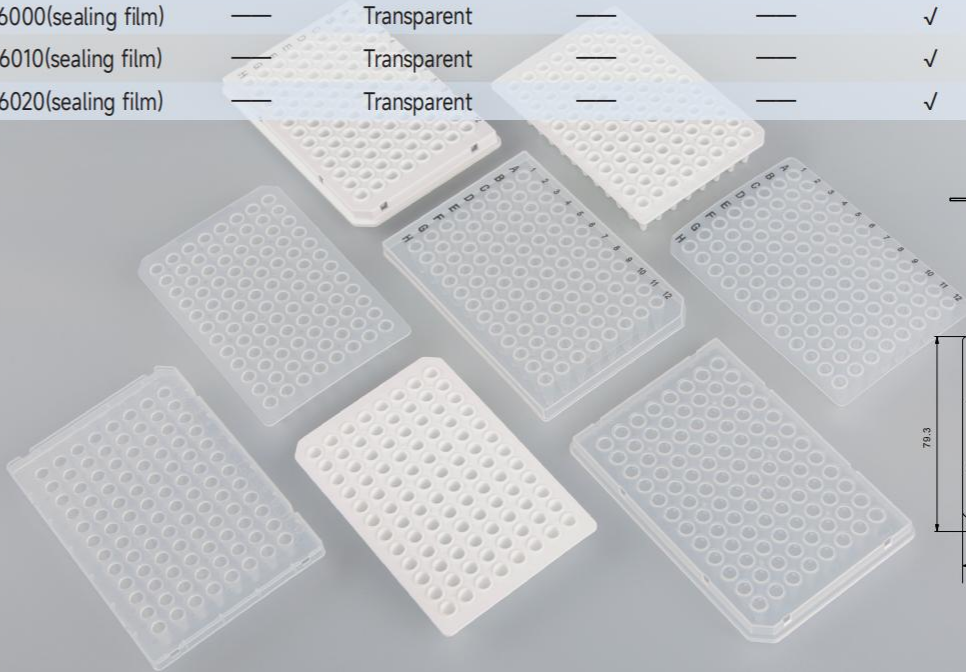

# Petri Dishes

## Product Feature

- Medical grade PS
- 60mm 90mm 150mm size for options
- Breathable design facilitates gas exchange
- Stacking design



Order No.	Product Size	Color	Sterile	Packing
401560	60mm	Transparent	✓	10pcs/bag,50bags/case
401690	90mm	Transparent	✓	10pcs/bag,50bags/case
401515	150mm	Transparent	✓	10pcs/bag,20bags/case

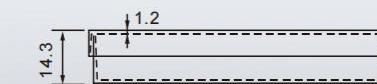
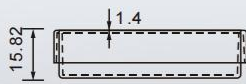
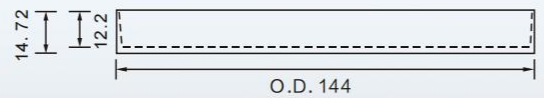
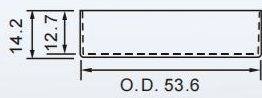
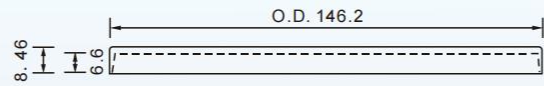
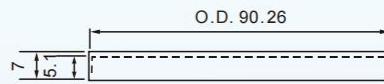
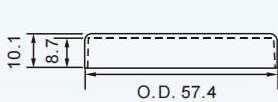

401560

401690

401515

Dimensions=mm

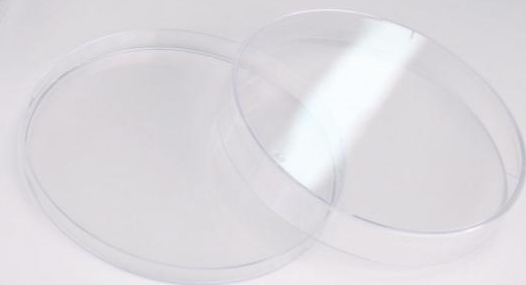

# Inoculating Loops & Needles

## Product Feature

- Medical grade HIPS material
- High product toughness, Convenient for marking and point planting
- Size 1ul and 10ul ,high Accuracy of inoculation volume
- The other end ok use for indicating needle
- E-beam sterile
- Sealed bag, cardboard instruction sheet inside , protect product with good shape .

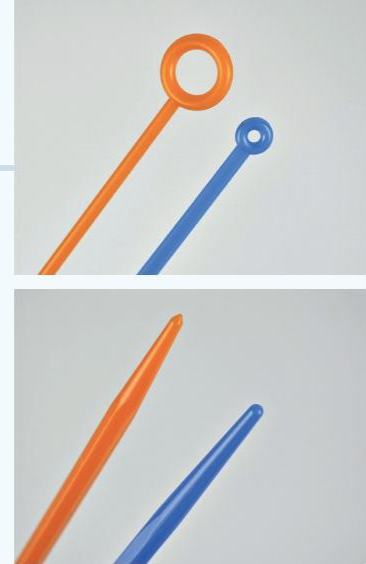

Order No.	Volume	Color	Sterile	Non-enzyme	Packing
550001	1μl	Blue	✓	✓	25pcs/bag,40bag/case
550101	1μl	Blue	✓	✓	Individually Wrapped, 500pcs/case
550002	10μl	Orange	✓	✓	25pcs/bag,40bag/case
550102	10μl	Orange	✓	✓	Individually Wrapped, 500pcs/case



550002

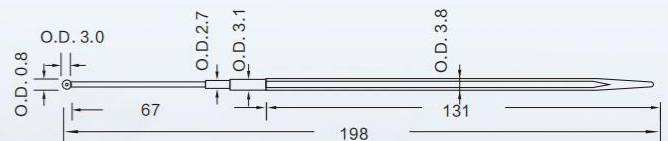

550001

Dimensions=mm



# Cell Spreader

## Product Feature

- Medical grade HIPS material
- Smooth surface ,Tail upward design reduces damage to the AGAR surface
- L-shape design easy for use
- E-beam sterile
- Pack : Plastic-paper individually packed and bulk packed



Order No.	Color	Sterile	Non-enzyme	Packing
560001	Orange	✓	✓	500pcs/case
560010	Orange	✓	✓	10pcs/bag,50bags/case

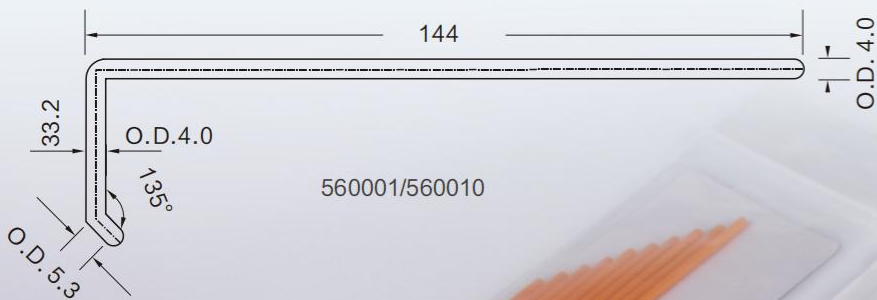

# PC Conical Flasks

Dimensions=mm

## Product Feature

- Medical grade PC
- More volume options
- Cap options: sealed cap , 0.2um Vent cap
- Temperature range: : **-80°C~121°C**
- E-beam sterile
- DNase & RNase free ,Non-Pyrogen

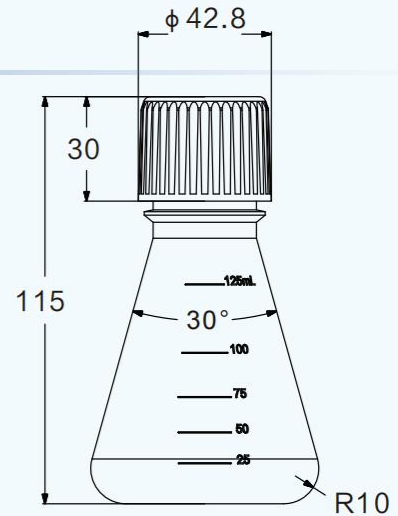

570125

Order No.	Volume	Sterile	Non-enzyme	Packing
570125	125ml	✓	✓	1pcs/bag,24pcs/case
570250	250ml	✓	✓	1pcs/bag,12pcs/case
570500	500ml	✓	✓	1pcs/bag,12pcs/case
571000	1000ml	✓	✓	1pcs/bag,6pcs/case
572800	2.8L	✓	✓	1pcs/bag,6pcs/case
575000	5L	✓	✓	1pcs/bag,4pcs/case



# Gloves

## Product Feature

- Style : Powder free latex & nitrile gloves for options
- Hypoallergenic, imported from Malaysia, Protein free, no allergic reaction
- Glove pattern design, convenient matching grasp operation
- CE and pass the biocompatibility test

Order No.	Material	Size	Color	Packing
520001	Nitrile	XS	Blue	100pcs/rack,10racks/case
520002	Nitrile	S	Blue	100pcs/rack,10racks/case
520003	Nitrile	M	Blue	100pcs/rack,10racks/case
520004	Nitrile	L	Blue	100pcs/rack,10racks/case
520005	Nitrile	XL	Blue	100pcs/rack,10racks/case
530001	Latex	XS	Natural	100pcs/rack,10racks/case
530002	Latex	S	Natural	100pcs/rack,10racks/case
530003	Latex	M	Natural	100pcs/rack,10racks/case
530004	Latex	L	Natural	100pcs/rack,10racks/case
530005	Latex	XL	Natural	100pcs/rack,10racks/case



# Serological Pipettes

## Product Feature

- Medical grade PS material
- Volume options : 1ml ----100ml 7 different colors
- Ascending and descending bi-directional scale design can intuitively read the amount of remaining liquid
- The polyolefin filter element can effectively prevent the damage of excessive suction to pipetting equipment
- E-beam sterile ,Non pyrogens, non cytotoxins, DNase& RNase free
- Package style : paper-plastic ;plastic -plastic bag for options, effectively prevent pollution, convenient access



Order No.	Volume	Color	pipette Nozzle style	Sterile	Non-enzyme	Style	Packing
720001	1ml	Yellow	one piece (extrusion style)	✓	✓	Individually Wrapped,paper-plastic Bag	50pcs/bag,10bags/case
720002	2ml	Green	one piece (extrusion style)	✓	✓	Individually Wrapped,paper-plastic Bag	50pcs/bag,10bags/case
720005	5ml	Blue	one piece (extrusion style)	✓	✓	Individually Wrapped,paper-plastic Bag	50pcs/bag,10bags/case
720010	10ml	Orange	two pieces (sonic welding style)	✓	✓	Individually Wrapped,paper-plastic Bag	50pcs/bag,8bags/case
720025	25ml	Red	two pieces (sonic welding style)	✓	✓	Individually Wrapped,paper-plastic Bag	25pcs/bag,8bags/case
720050	50ml	Black	two pieces (sonic welding style)	✓	✓	Individually Wrapped,paper-plastic Bag	25pcs/bag,4bags/case
720100	100ml	Purple	two pieces (sonic welding style)	✓	✓	Individually Wrapped,paper-plastic Bag	25pcs/bag,4bags/case
721001	1ml	Yellow	one piece (extrusion style)	✓	✓	Individually Wrapped,plastic Bag	50pcs/bag,10bags/case
721002	2ml	Green	one piece (extrusion style)	✓	✓	Individually Wrapped,plastic Bag	50pcs/bag,10bags/case
721005	5ml	Blue	one piece (extrusion style)	✓	✓	Individually Wrapped,plastic Bag	50pcs/bag,10bags/case
721010	10ml	Orange	one piece (extrusion style)	✓	✓	Individually Wrapped,plastic Bag	50pcs/bag,8bags/case
721025	25ml	Red	two pieces (sonic welding style)	✓	✓	Individually Wrapped,plastic Bag	25pcs/bag,8bags/case
721050	50ml	Black	two pieces (sonic welding style)	✓	✓	Individually Wrapped,plastic Bag	25pcs/bag,4bags/case
721100	100ml	Purple	two pieces (sonic welding style)	✓	✓	Individually Wrapped,plastic Bag	25pcs/bag,4bags/case

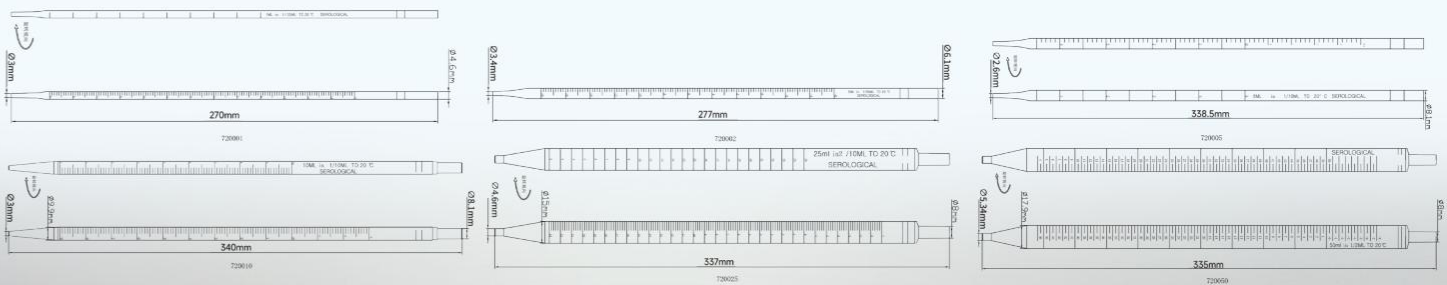

Dimensions=mm





# Cell Strainer

## Product Feature

- Imported nylon screen
- Size options : 40µm, 70µm and 100µm
- Artificial mechanical design, round handle, easy to operate
- Fit 50ml centrifuge tube
- DNase & RNase free ,non-endotoxin
- Individually packaged, E- beam sterilized



Order No.	Mesh aperture	Color	Sterile	Non-enzyme	Style	Packing
700040	40µm	Blue	√	√	Individual	100pcs/case
700070	70µm	White	√	√	Individual	100pcs/case
700100	100µm	Yellow	√	√	Individual	100pcs/case

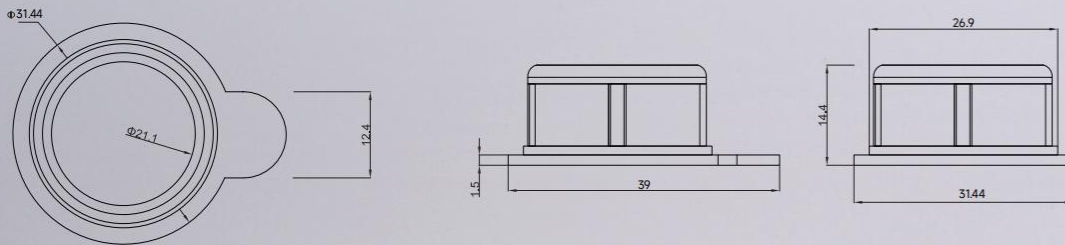

Dimensions=mm



# Cell Culture Dishes

Dimensions=mm

## Product Feature

- High transparency polystyrene material
- Bottom surface is flat and transparent, and will not emit light and distort under the microscope
- Stack positioning ring, easy to stack
- Plate cover ventilation grille design to ensure gas exchange
- The culture surface was treated by vacuum plasma (TC), and the cell adhesion was good
- Electron beam sterilization, sterile packaging
- no pyrogens , no endotoxin

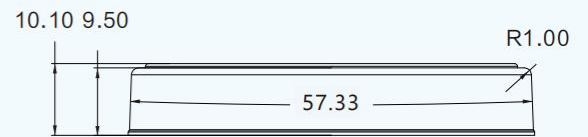

760060

Order No.	Size	TC Treated	Grip ring	Sterile	Non-enzyme	Packing
760035	35×10mm	✓	✗	✓	✓	20pcs/bag, 25bags/case
760060	60×15mm	✓	✗	✓	✓	20pcs/bag, 25bags/case
760100	100×20mm	✓	✗	✓	✓	10pcs/bag, 30bags/case
760035-1	35×10mm	✓	✓	✓	✓	20pcs/bag, 25bags/case
760060-1	60×15mm	✓	✓	✓	✓	20pcs/bag, 25bags/case
760100-1	100×20mm	✓	✓	✓	✓	10pcs/bag, 30bags/case
760150-1	150×20mm	✓	✓	✓	✓	5pcs/bag, 12bags/case
762035	35×10mm	✗	✓	✓	✓	10pcs/bag, 50bags/case
762060	60×15mm	✗	✓	✓	✓	10pcs/bag, 50bags/case
762100	100×20mm	✗	✓	✓	✓	10pcs/bag, 30bags/case
762150	150×20mm	✗	✓	✓	✓	5pcs/bag, 12bags/case



# Confocal Petri Dishes

## Product Feature

- High transparent PS material, easy to observe
- The plate cover and plate bottom are set with multiple card positions and slots to meet the diversity and convenience of the experiment
- Imported borosilicate glass bottom, the bottom surface is smooth and transparent, effectively avoid the depolarization of light
- E-beam sterilization, sterile packaging
- Non-endotoxin

Order No.	Hole Diameter	TC Treated	Sterile	Non-enzyme	Packing
763015	15mm	✓	✓	✓	10pcs/bag, 20bags/case
763020	20mm	✓	✓	✓	10pcs/bag, 20bags/case
763515	15mm	✓	✓	✓	Blister individual packaging, 20pcs/box, 10boxes/case
763520	20mm	✓	✓	✓	Blister individual packaging, 20pcs/box, 10boxes/case

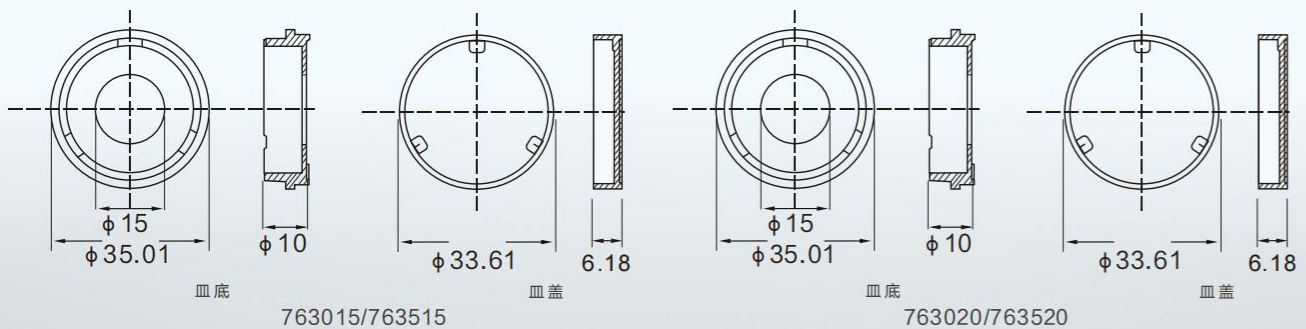

# Cell Culture Flasks

## Product Feature

- high transparent PS material
- Bottle side matt surface, writing area, clear scale
- Stack design is not easy to slip, easy to stack
- E-beam sterilization
- Non-pyrogens ,non- endotoxin

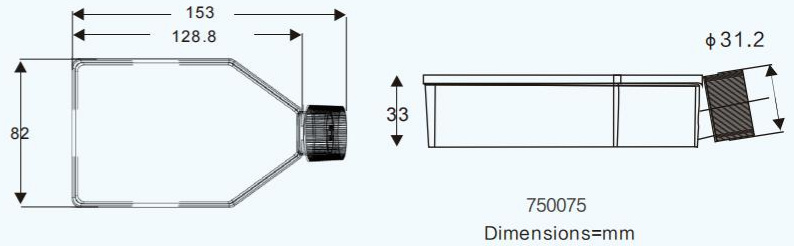

Order No.	Culture area	Volume	Cover	TC Treated	Sterile	Non-enzyme	Packing
750025	25cm <sup>2</sup>	50ml	Breathable	✓	✓	✓	12pcs/bag, 25bags/case
750075	75cm <sup>2</sup>	250ml	Breathable	✓	✓	✓	5pcs/bag, 18bags/case
750175	175cm <sup>2</sup>	750ml	Breathable	✓	✓	✓	5pcs/bag, 10bags/case
750225	225cm <sup>2</sup>	950ml	Breathable	✓	✓	✓	5pcs/bag, 5bags/case
751025	25cm <sup>2</sup>	50ml	Breathable	✓	✓	✓	10pcs/bag, 20bags/case
751075	75cm <sup>2</sup>	250ml	Breathable	✓	✓	✓	5pcs/bag, 20bags/case
751175	175cm <sup>2</sup>	750ml	Breathable	✓	✓	✓	5pcs/bag, 10bags/case
751225	225cm <sup>2</sup>	950ml	Breathable	✓	✓	✓	5pcs/bag, 5bags/case
752025	25cm <sup>2</sup>	50ml	Sealed	✗	✓	✓	10pcs/bag, 20bags/case
752075	75cm <sup>2</sup>	250ml	Sealed	✗	✓	✓	5pcs/bag, 20bags/case
752175	175cm <sup>2</sup>	750ml	Sealed	✗	✓	✓	5pcs/bag, 10bags/case
752225	225cm <sup>2</sup>	950ml	Sealed	✗	✓	✓	5pcs/bag, 10bags/case
753025	25cm <sup>2</sup>	50ml	Sealed	✗	✓	✓	10pcs/bag, 20bags/case
753075	75cm <sup>2</sup>	250ml	Sealed	✗	✓	✓	5pcs/bag, 20bags/case
753175	175cm <sup>2</sup>	750ml	Sealed	✗	✓	✓	5pcs/bag, 10bags/case
753225	225cm <sup>2</sup>	950ml	Sealed	✗	✓	✓	5pcs/bag, 10bags/case



# Cell Culture Plates

## Product Feature

- High transparency PS material
- Cover cut Angle design with condensation ring reduces the chance of contamination
- Each hole is coded, easy to distinguish and identify
- No pyrogen, no endotoxin, DNase&RNase free
- E-beam sterilization

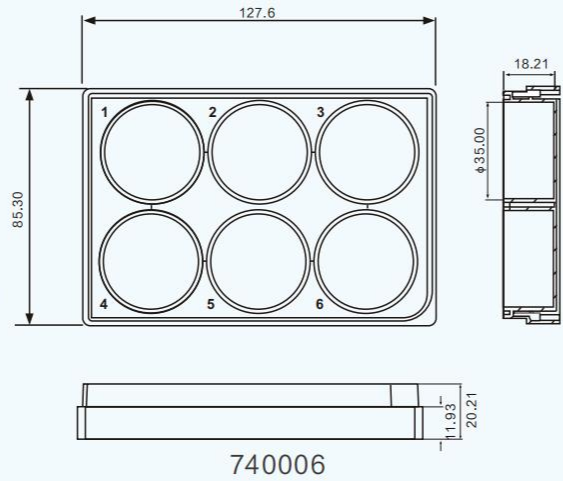

740006

Dimensions=mm

Order No.	Dimension	Seeding density	Growth medium (ml)	TC Treated	Sterile	Non-enzyme	Style	Packing
740006	6-well, 84.4x127.6mm	9.5cm <sup>2</sup>	1.9-2.9ml	✓	✓	✓	Individual	50pcs/case
740012	12-well, 84.4x127.6mm	3.6cm <sup>2</sup>	0.76-1.14ml	✓	✓	✓	Individual	50pcs/case
740024	24-well, 84.4x127.6mm	1.9cm <sup>2</sup>	0.38-0.57ml	✓	✓	✓	Individual	50pcs/case
740048	48-well, 84.4x127.6mm	0.88cm <sup>2</sup>	0.19-0.285ml	✓	✓	✓	Individual	50pcs/case
740096	96-well, 84.4x127.6mm	0.32cm <sup>2</sup>	0.1-0.2ml	✓	✓	✓	Individual	50pcs/case
742006	6-well, 84.4x127.6mm	9.5cm <sup>2</sup>	1.9-2.9ml	×	✓	✓	Individual	50pcs/case
742012	12-well, 84.4x127.6mm	3.6cm <sup>2</sup>	0.76-1.14ml	×	✓	✓	Individual	50pcs/case
742024	24-well, 84.4x127.6mm	1.9cm <sup>2</sup>	0.38-0.57ml	×	✓	✓	Individual	50pcs/case
742048	48-well, 84.4x127.6mm	0.88cm <sup>2</sup>	0.19-0.285ml	×	✓	✓	Individual	50pcs/case
742096	96-well, 84.4x127.6mm	0.32cm <sup>2</sup>	0.1-0.2ml	×	✓	✓	Individual	50pcs/case



# ELISA Plate

## Product Feature

- Medical grade polystyrene material
- Removable for use in ELISA experiments
- In accordance with ANSI-SBS standard, CV value between holes <5%
- No DNase, RNase, no endotoxin
- Transparent plate: Suitable for quantitative and qualitative solid-phase immunoassay and combination assay
- White plate: suitable for self-luminescence, chemiluminescence
- Black plate: Suitable for fluorescence immunoassay and combination assay

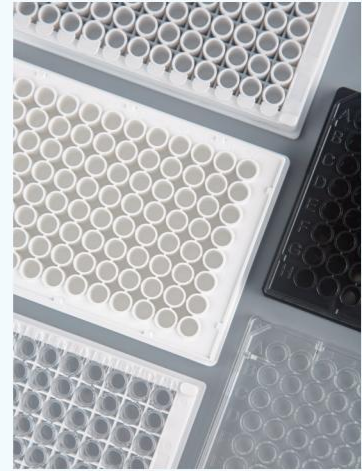

Order No.	Volume	Color	Type	Sterile	Binding	Packing
770001	0.3ml	Transparent	Non-detachable Medium	×	Middle	10pcs/bag, 20bags/case
770010	0.3ml	Transparent	Non-detachable High	×	High	10pcs/bag, 20bags/case
770002	0.3ml	White	Non-detachable Medium	×	Middle	10pcs/bag, 20bags/case
770020	0.3ml	White	Non-detachable High	×	High	10pcs/bag, 20bags/case
770003	0.3ml	Black	Non-detachable Medium	×	Middle	10pcs/bag, 20bags/case
770030	0.3ml	Black	Non-detachable High	×	High	10pcs/bag, 20bags/case
772001	0.4ml	Transparent	F8*12	×	High	10pcs/bag, 20bags/case

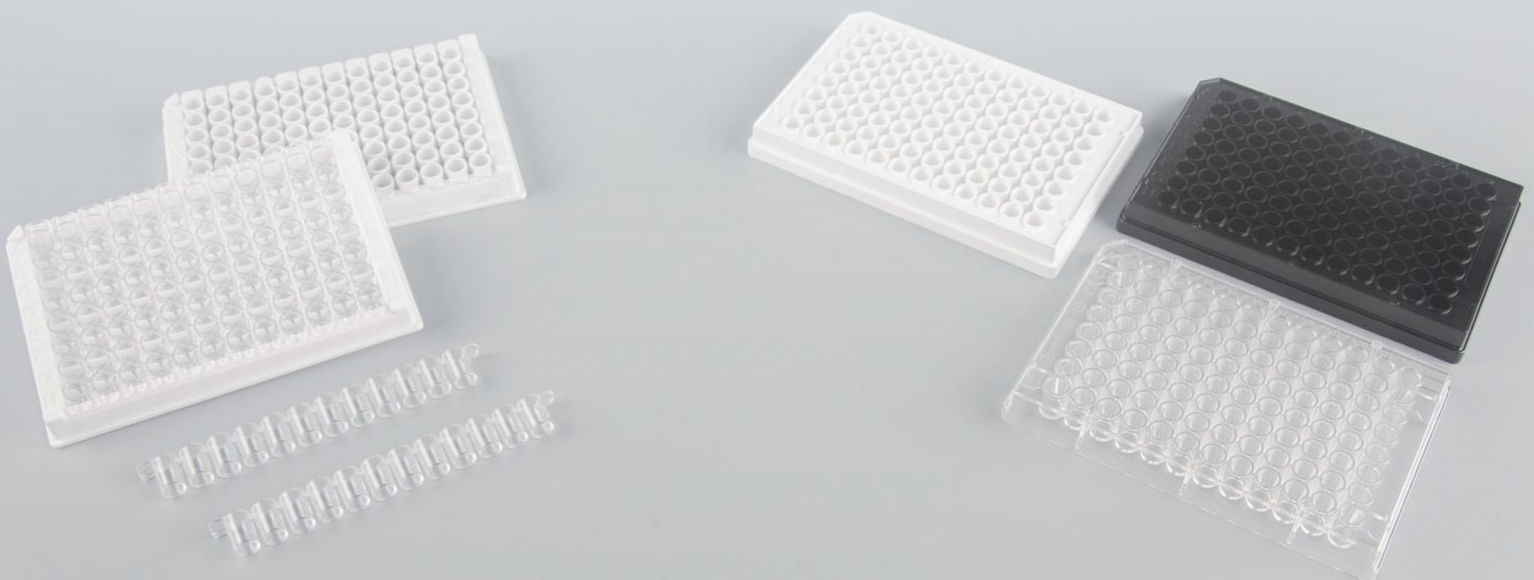

## CONTACT US

### ZHEJIANG RONGDA BIOTECHNOLOGY CO., LTD.

Tel: 0576-84080099

Website: [www.rongda-bio.com](http://www.rongda-bio.com)

Address: Building 1, No. 999, Beiyuan Road, Xinqian street,  
HuangyanArea, Taizhou City, Zhejiang Province, China

